

Sept 38

RADIO'S GREATEST MAGAZINE

September

25 Cents

in United States and Canada

OVER 175 ILLUSTRATIONS

HUGO GERNSBACK
EDITOR

Radio-Craft

Radio Broadcasting Class
2:15 Today



NOW!
 Reading, Writing, Arithmetic
 ... And RADIO!
 See Page 145

Radio in War Games • Pushbutton Set-Tester! • A 3-Octave Electronic Organ!

"High-Seas 4" Lamp Radio • Noise-Reducing Antennas • When Television Comes!

OVER 50,000 RADIO MEN READ RADIO-CRAFT MONTHLY

SUPERIOR PRESENTS 5 INSTRUMENTS

from its NEW 1130 series!!!! Never before has Superior offered so much for so little! Always the Best Buy in the Instrument Field. Superior in this new 1100 series gives you even more value! We have incorporated many refine-

ments, many new features . . . all proven to be sound and practical. We urge you to read the descriptions below carefully; see how these instruments fit your needs. Buy direct from manufacturer and save 50%.

THE NEW MODEL 1110-S A.C. - D.C. VOLT OHM MILLIAMMETER A Midget in Size — A Giant in Performance



Features modern 0-1 d'Arsonval type meter precision resistors, neat etched panel housed in new striped fabricoid case.

SPECIFICATIONS:		
0-1.5 volts D.C.	0-500 ohms 500-500,000 ohms.	0-15 volts A.C.
0-15 volts D.C.	0-1 ma. D.C.	0-40 volts A.C.
0-25 volts D.C.	0-10 ma. D.C.	0-75 volts A.C.
0-75 volts D.C.	0-100 ma. D.C.	0-200 volts A.C.
0-500 volts D.C.	0-500 ma. D.C.	0-1200 volts A.C.

Model 1110-S supplied complete with batteries, test leads and instructions. Size: 8 1/2" x 5" x 3 1/4". Shipping weight, 5 1/2 pounds. Our net price

\$7⁸⁵

THE NEW MODEL 1130-S

Signal Generator with Audio Frequencies



SPECIFICATIONS:

1. Combination R.F. and Audio Signal Generator, R.F. 100 kc. to 100 Mc., A.F.—100 7,500 cycles. All Direct reading, all by front panel switching. 2. R.F. and A.F. output independently obtainable alone or with A.F. (any frequency) modulating R.F. 3. Accuracy is within 1% on I.F. and Broadcast bands; 2% on higher frequencies. 4. Audio frequencies in 3 bands: 100, 400, 1000, 5000, and 7500 cycles. 5. Giant airplane full vision, direct reading dial. 6. Condenser and other leakages tested to 100 megohms. 7. All services on 90-130 volts A.C. or D.C. (any frequency).

Model 1130-S comes complete with tubes, test leads, carrying handle, instructions. Size 12" x 9" x 6 1/2". Shipping weight 15 pounds. Our net price

\$11⁸⁵

THE NEW MODEL 1150-S SUPER-ALLMETER

Featuring the New Sloping Panel



A genuine achievement! For accurate and rapid measurements. Note the following features: A.C. and D.C. Volts, A.C. and D.C. currents, Resistance, Capacity, Inductance, Decibels, Watts.

SPECIFICATIONS:

D.C. Voltage: 0-15, 0-150, 0-750 volts D.C.
A.C. Voltage: 0-15, 0-150, 0-750 volts A.C.
D.C. Current: 0-1, 0-15, 0-150, 0-750 ma. D.C.
A.C. Current: 0-15, 0-150, 0-750 ma. A.C.
2 Resistance Ranges: 0-500 ohms
500-5 megohms
High and Low Capacity Scales: .0005 to 1 mfd. and .05 to 200 mfd.
3 Decibel Ranges: -10 to +19, -10 to +38, -10 to +53.
Inductance: 1 to 700 Henries
Watts:
Based on 6 mw. at 0 D.B. in 500 ohms, .006000 to 600
Utilizes new 4 1/2" square 0-1 d'Arsonval type meter with precision resistors housed in our newly devised sloping case for rapid and accurate servicing.
Model 1150-S supplied complete with test leads, tabular charts and instructions. Size 10" x 7 3/4" x 4 1/4", shipping weight 9 pounds. Our net price
Model 1150-A Portable carrying cover 75c additional.

\$11⁸⁵

THE NEW MODEL 1180-S SET TESTER

A Complete Laboratory All In One Unit!

Featuring Our New Type Sloping Panel for Precise and Rapid Servicing



A complete testing laboratory all in one unit! Combines Superior models 1140-S and 1150-S. For specifications read the description of both these models herewith. Comes housed in sturdy, black case with sloping panel for rapid and simple measurements. Complete with test leads, tabular charts, instructions and tabular data for every known receiving type tube, including many transmitting types. Size 11 1/2" x 9 1/4" x 5 1/2", shipping weight 18 pounds Our net price
Model 1180-A for Portable Cover, add 95c.

\$17⁸⁵

THE NEW MODEL 1140-S TUBE TESTER



A really modern tube tester conforming to all standards of good engineering practice. Utilizes a 3" d'Arsonval type meter with calibrated scale. Furnished in a sturdy black case with sloping panel for easy operation. Removable cover and carrying handle for either portable or counter use.

SPECIFICATIONS:

1. Tests all 4, 5, 6, 7, 7B, and octal base tubes, including diodes.
2. Tests by the well established emission method for tube quality, directly read on the GOOD? BAD? scale of the meter.
3. Affords accurate heat test for leakage and shorts between elements.
4. All services performed by the use of only five controls at maximum, and many tests do not require working all the controls.
5. Supplied with instructions and reference table so that the filament voltage and emission measuring controls may be properly set for the enumerated long list of tubes, which includes all tubes commonly encountered in servicing.
6. Works on 90-120 volts A.C., 60 cycle A.C.
Model 1140-S comes complete with instructions and tabular data for every known receiving type of tube as well as many transmitting types. Shipping weight 10 pounds, size 10" x 7 1/4" x 4 1/4". Our net price
Model 1140-A with Portable Cover 75c additional

\$10⁸⁵

**SUPERIOR INSTRUMENT CO. 136 Liberty St., Dept. 938
NEW YORK, N. Y.**



J. E. SMITH
President
National Radio
Institute
Established 1914
The man who has
directed the
home study train-
ing of more men
for the Radio In-
dustry than any
other man in
America.

I WILL TRAIN YOU TO START A SPARE TIME OR FULL TIME RADIO SERVICE BUSINESS WITHOUT CAPITAL

**HERE ARE A FEW EXAMPLES
OF THE KIND OF MONEY
I TRAIN MY MEN TO MAKE**



**\$200 TO \$300 A MONTH
IN OWN BUSINESS**

"For the last 18 months I have been in business for myself, making between \$200 and \$300 a month. I have N.R.I. to thank for my start in this field."—**ALLEN J. FROELICHER**, 224 W. Texas Ave., Goose Creek, Texas.

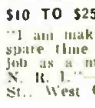

\$10 TO \$25 A WEEK IN SPARE TIME

"I am making from \$10 to \$25 a week in spare time while still holding my regular job as a machinist. I owe my success to N. R. I."—**WM. F. RUPP**, 203 W. Front St., West Conshohocken, Pa.



CHIEF OPERATOR BROADCASTING STATION

"When I completed 20 lessons, I obtained my Radio Broadcast Operator's License and immediately joined Station WMPG, where I am now Chief Operator."—**HOLLIS F. HAYES**, 85 Madison St., Lanier, Mich.

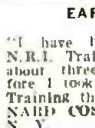

**EARNINGS TRIPLED BY
N.R.I. TRAINING**

"I have been doing nicely, thanks to N.R.I. Training. My present earnings are about three times what they were before I took the Course. I consider N.R.I. Training the finest in the world."—**BERT NARDI COSTA**, 201 Kent St., Brooklyn, N. Y.



OVER \$1,000 BEFORE GRADUATING

"Before completing half the N.R.I. Course I was servicing sets, and I made \$1,000 to \$1,200 before graduating. I am doing Radio service work for myself now."—**ASHLEY G. ALDRIDGE**, 1228 Shepherd St., Petersburg, Va.

**Get My LESSON on Radio
Servicing Tips FREE**

I want to prove my Training gives practical, money-making information, that it is easy to understand—what you need to master Radio. My sample lesson text, "Radio Receiver Troubles—Their Cause and Remedy," covers a long list of Radio receiver troubles in A.C., D.C., battery, universal, auto, T. R. F., superheterodyne, all-wave, and other types of sets. And a cross reference system gives you the probable cause and a quick way to locate and remedy these set troubles. A special section is devoted to receiver check-up, alignment, balancing, neutralizing, testing. You can get this lesson Free by mailing the coupon.



**The Tested WAY
to BETTER PAY**

Do you want to make more money? The world-wide use of Radio has made many opportunities for you to have a spare time or full time Radio service business of your own. Four out of every five homes in the United States have Radio sets which regularly need repairs, new tubes, etc. Servicemen can earn good commissions selling new sets to owners of old models. Even if you have no knowledge of Radio or electricity, I will train you at home in your spare time to sell, install, fix, all types of Radio sets; to start your own Radio business and build it up on money you make in your spare time while learning. Mail coupon for my 64-page book. It's Free—it shows what I have done for others—what I am ready to do for you.

**Many Make \$5, \$10, \$15 a Week Extra
in Spare Time While Learning**

The day you enroll I start sending you Extra Money Job Sheets. They show you how to do Radio repair jobs, how to cash in quickly. Throughout your training I send you plans and ideas that have made good spare time money—from \$200 to \$500 a year—for hundreds of fellows. I send you special Radio equipment, show you how to conduct experiments, build circuits, illustrating important Radio principles. You get PRACTICAL EXPERIENCE while learning.

**There's a Real Future in Radio
for Well Trained Men**

In 1937 Radio enjoyed one of its most prosperous years. Nearly \$500,000,000 worth of sets, tubes and parts were sold. Over 5,000,000 home Radios were sold—25,000,000 homes (1 out of 5 in the U. S.) now have one or more sets. Over 1,800,000 auto Radios were sold—5,000,000 cars now have Radios. Every year millions of sets go out of date, are replaced with newer models. Every year millions of dollars are spent in transmitting equipment, television developments, etc. The \$30, \$50, \$75 a week jobs have grown from a few hundred 20 years ago to thousands today. And Radio is still a young industry—developing fast.

**Get Ready Now for Your Own Radio Business
and for Jobs Like These**

Radio broadcasting stations employ engineers, operators, station managers and pay up to \$5,000 a year. Fixing Radio sets in spare time pays as much as \$200 to \$500 a year—full time repair jobs with Radio jobbers, manufacturers and dealers, as much as \$30, \$50, \$75 a week. Many Radio Experts open their own full time or part time Radio sales and repair businesses. Radio manufacturers and jobbers employ testers, inspectors, foremen, engineers, servicemen, paying up to

\$6,000 a year. Automobile, police, aviation, commercial Radio, loud speaker systems are newer fields offering good opportunities. Television promises to open many good jobs soon. Men I have trained are holding good jobs in these branches of Radio. Read their statements in my 64-page book. Mail the coupon.

**I ALSO GIVE YOU A PROFESSIONAL
SERVICING
INSTRUMENT**



Here is the instrument every Radio expert needs and wants—an All-Wave, All-Purpose, Set Servicing Instrument. It contains everything necessary to measure A.C. and D.C. voltages and current; to test tubes, resistance; adjust and align any set, old or new. It satisfies your needs for professional servicing after you graduate—can help you make extra money fixing sets while training.

**Save Money—Learn At Home
Money Back Agreement Protects You**

I am sure I can train you at home successfully. I will agree in writing to refund every penny you pay if you are not satisfied with my Lessons and Instruction Service when you finish. You get a copy of this agreement with my Book.

**Find Out What Radio Offers You
Get My 64-Page Book Free Now**

Act Today. Mail the coupon now for my Free Lesson and my book, "Rich Rewards in Radio." Both are free to anyone over 16 years old. My book points out Radio's spare time and full time opportunities and those coming in Television; tells about my Training in Radio and Television; shows you letters from men I have trained, telling what they are doing and earning. Find out what Radio offers YOU! MAIL THE COUPON in an envelope, or paste it on a penny post card—NOW!

**J. E. SMITH, President
National Radio Institute,
Dept. 8JX
Washington, D. C.**

**THIS
FREE BOOK
HAS HELPED
HUNDREDS OF
MEN MAKE
MORE
MONEY**

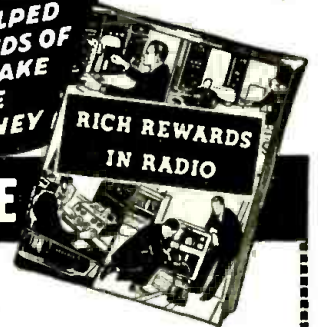

**GOOD FOR BOTH 64 PAGE BOOK FREE
SAMPLE LESSON FREE**

**J. E. SMITH, President, National Radio Institute,
Dept. 8JX, Washington, D. C.**

Without obligating me, send your Lesson "Radio Receiver Troubles—Their Cause and Remedy," and free book about spare time and full time Radio opportunities and how I can train for them at home in my spare time—about the N.R.I. Set Servicing Instrument. I am particularly interested in the branch of Radio checked below:

- | | |
|---|--|
| <input type="checkbox"/> Radio Service Business of My Own | <input type="checkbox"/> Loud Speaker Systems, Installations and Service |
| <input type="checkbox"/> Spare Time Radio Repair Work | <input type="checkbox"/> Auto Radio Installation and Service |
| <input type="checkbox"/> Retail Sales of Radio Sets and Equipment | <input type="checkbox"/> Television Station Operator |
| <input type="checkbox"/> Service Expert for Retail Stores | <input type="checkbox"/> Service Expert with Radio Factory |
| <input type="checkbox"/> Broadcasting Station Operator | <input type="checkbox"/> Commercial Radio Station Operator |
| <input type="checkbox"/> Aviation Radio Operator | <input type="checkbox"/> All-around Servicing Expert |

(If you have not decided which branch you prefer—mail coupon now, for information to help you decide.)

NAME AGE

ADDRESS 14X1

Please Say That You Saw It in RADIO-CRAFT



HUGO GERNSBACK, Editor-in-Chief

N. H. LESSEM
Associate Editor

ROBERT EICHBERG
Trade Digest Editor

R. D. WASHBURNE
Managing Editor

CONTENTS — Sept. 1938, Issue

Volume X

Number 3

Editorial: School-Room Broadcasting..Hugo Gernsback	133
The Radio Month in Review.....	134
"Electronics"—A Car-Maker's Genie.....	136
War Gamel.....R. D. Washburne	137
Servicemen! Build This 38-Range "Pushbutton" Bench Tester—Part I.....Charles Sicuranza	138
New Circuits in Modern Radio Receivers—No. 12F. L. Sprayberry	141-142
How to Make a 3-Octave Electronic Organ for \$20M. L. Groder	143-144
Reading 'Riting 'Rithmetic . . . and Radio!.....	146
40-Watt Phone—C.W. Transmitter for 5-, 10-, and 20- Meter Bands.....Oliver Read, W9ETI	147
When Television Comes Around I.....C. A. Tuthill	148
Servicing Questions & Answers.....	150
Operating Notes	151
The "High Seas 4" Utility Lamp-Radio....N. H. Lessem	152
High-Fidelity Goes to Town!.....W. J. Zaun	154
An Open Letter to the Radio Industry from Hugo Gernsback	155

The Principles of Noise-Reducing Antenna SystemsJ. G. Aceves	156
Automatic Frequency Control Alignment Made Easy	158
New Set-Up for Practicing Code.....Eli M. Lurie	159
Radio Wittiquiz	159
RADIO SERVICE DATA SHEETS:	
No. 235—RCA-Victor Model HF-1 (Symphony) High-Fidelity 8-Tube Superhet.....	159A
No. 236—Ditto (continued).....	159B
Radio Trade Digest.....	160
The Latest Radio Equipment.....	162
Pushbutton Signal Generator.....Samuel C. Milbourne	163
Useful Circuit Ideas.....	165
Book Review	190-192

TEST EQUIPMENT NUMBER

The rapid expansion of the fields of Radio, Electronics and Public Address has resulted in the development of many new testing devices. The fact that these new test instruments save time, are more efficient, or are less expensive than preceding apparatus makes it worthwhile for Servicemen and other technicians in these respective fields to read the forthcoming October issue of Radio-Craft in which the new devices are given special attention.

Of course set builders, sound specialists and other radio groups will find, as usual, articles of especial interest in this same issue—

—on the newsstands September 1.

Published by Radcraft Publications, Inc. Publication office: 29 Worthington Street, Springfield, Mass. Editorial and Advertising Offices: 99 Hudson Street, New York City. Chicago Advertising Office: RADIO-CRAFT, 520 North Michigan Avenue, Chicago, Ill.

Foreign Agents:

London—Gorrings's American News Agency, 9A Green St., Leicester Square, W. C. 2, England.
Paris—Messageries Dawson, 4 Rue Faubourg, Poissonniere, France.
Melbourne—McGill's Agency, 179 Elizabeth St., Australia.
Dunedin—James Johnston, Ltd., New Zealand.

RADIO-CRAFT is published monthly, on the first of the month preceding that of date; subscription price is \$2.50 per year in U. S. and Canada. (In foreign countries, \$3.00 a year to cover additional postage.) Entered at the post office at Springfield as second-class matter under the act of March 3, 1879.

Text and illustrations of this magazine are copyright and must not be reproduced without permission of the copyright owners.

Copyright 1938 Radcraft Publications, Inc.

MANY OPPORTUNITIES FOR THE COYNE TRAINED RADIO MAN



Are You Ready for a Better Job - More Pay?

Don't be an untrained man. Let me show you how to get your start in Radio — a fast growing, live money-making industry.

Prepare for jobs as Assembler, Inspector and Tester—Radio Sales or Service and Installation Work—Broadcasting Station Operator—Wireless Operator on a Ship or Airplane or Sound Work—HUNDREDS OF OPPORTUNITIES for a real future in radio!

12 Weeks of Shop Training

We don't teach by book study. We train you on a great outlay of Radio, Television and Sound equipment—on scores of modern Radio Receivers, actual Broadcasting equipment, Television apparatus and Sound Reproduction equipment, Code and Telegraph equipment, etc. You don't need advanced education or previous experience. We give you — RIGHT HERE IN THE COYNE SHOPS — the actual practice and experience you'll need for your start in this great field. And because we cut out all useless theory and only give that which is necessary you get a practical training in 12 weeks. Mail coupon for all facts about my school and training methods.

TELEVISION *and* PUBLIC ADDRESS

Television is sure to come as a commercial industry. Rapid progress is now being made in developing this new field. It will offer opportunities to the man who is trained in Radio. Here at Coyne you learn Television principles, and work on actual Television equipment. Public Address Systems offer opportunities to the Trained Radio Man. Here is a great new Radio field which is rapidly expanding. Prepare NOW for these wonderful opportunities! Learn Radio Sound Work at COYNE on actual Sound Reproduction equipment. Not a home study course.

SEND FOR DETAILS OF MY "PAY AFTER GRADUATION" PLAN

Mail the Coupon below and I'll tell you about my "Pay After Graduation" Plan which has enabled hundreds of others to get Coyne training with very little money. On this plan you can get your training first, then take 18 months to complete your small monthly tuition payments starting 5 months after you begin training. Not a home study course.

Mail the coupon for all details of this "Tuition Payment Plan."

PRACTICAL WORK at COYNE in Chicago

ACTUAL, PRACTICAL WORK. You build and service radio sets. You get training on real Broadcasting equipment. You construct Television Receiving Sets and actually transmit your own Television images over our Television equipment. You work on real Sound equipment. You learn Wireless Operating on Actual Code Practice apparatus. We don't waste time on useless theory. We give you the practical training you'll need for your start in Radio—in 12 short weeks. If you desire code, this requires additional time for which there is no extra charge.

Mail Coupon Today for All the Facts

H. C. LEWIS, Pres. RADIO DIVISION Founded 1899

Coyne Electrical School
500 S. Paulina St., Dept. D8-8H, Chicago, Ill.

ELECTRIC REFRIGERATION AIR CONDITIONING AUTOMOBILE ELECTRICAL WORK

Instruction now included at no extra cost. Here is your opportunity to learn these valuable allied lines without extra tuition charge.

PART TIME EMPLOYMENT TO HELP YOU "EARN WHILE LEARNING"

If you are short of money and need part time employment to help pay for your room and board while training, my Employment Department will help you get a part time job.



GET THE FACTS

Don't let lack of money prevent your sending in the Coupon. Mail the Coupon today and I Will send you the Big FREE Coyne Book full of FACTS.

H. C. LEWIS, Pres.
Radio Division, Coyne Electrical School
500 S. Paulina St., Dept. D8-8H, Chicago, Ill.

Dear Mr. Lewis:—Send me your Big Free Radio Book, and all details of your "Pay After Graduation" Plan including valuable instruction in Electric Refrigeration, Air Conditioning and Automobile Electrical Work.

Name.....
Address.....
City.....State.....

Please Say That You Saw It in RADIO-CRAFT

50 PRIZE AWARDS

to Readers of RADIO-CRAFT

Yes

—Mr. Radio Man—there's a big prize contest sponsored by RADIO-CRAFT starting August 1, 1938 and ending midnight September 29, 1938. Just sixty days to get one of **FIFTY PRIZES OFFERED** by the publishers of RADIO-CRAFT.

You

—are invited to compete in the most unique, yet simple contest celebrating **RADIO-CRAFT'S Tenth Anniversary**.

Can

—you imagine a contest so easy that you answer only five questions and write a thirty-word sentence—then submit your entry.

Win

—a prize that really is a prize. Every award is invaluable to Radio men regardless of the branch of the industry you serve.

Clip Coupon

—fill it in carefully and mail to the publishers today. A special 4-page circular giving complete details and listing the awards in this big contest, will be sent to you immediately. This coupon, or a facsimile thereof is your only requirement to enter this great Anniversary Contest.

You Will Want to Enter This BIG CONTEST!

Regardless of the branch of radio in which you are now employed the privilege of entering this contest is open to you. Whether you are president of a manufacturing concern, dealer or Service man, jobber or wholesaler, P.A. engineer or set builder, the publishers welcome you to enter this contest. Every contestant HAS AN EQUAL CHANCE TO WIN ANY ONE OF THE FIFTY AWARDS. Fill in the coupon at the right . . . mail it immediately to the publishers for complete details. Don't delay.

RADIO-CRAFT · 99 HUDSON ST · NEW YORK, N.Y.

OFFICIAL CONTEST ENTRY BLANK

RADIO-CRAFT, Contest Editor
99 Hudson St., New York, N. Y.

I wish to enter the **RADIO-CRAFT TENTH ANNIVERSARY CONTEST OF 50 PRIZE AWARDS**. Please consider this my application of entry and therefore send me the 4-page circular giving complete details about this contest and the list of awards to be made. The coupon has been filled in properly.

PLEASE CHECK ONLY ONE—THAT WHICH IS MOST APPROPRIATE FOR YOUR OWN CLASSIFICATION.

- | | |
|--|---|
| <input type="checkbox"/> Radio Dealer | <input type="checkbox"/> Radio Experimenter |
| <input type="checkbox"/> Independent Radio Service Man | <input type="checkbox"/> Licensed Amateur |
| <input type="checkbox"/> Service Man for Jobber | <input type="checkbox"/> Public Address Engineer |
| <input type="checkbox"/> Service Man for Dealer | <input type="checkbox"/> Professional Set Builder |
| <input type="checkbox"/> Service Man for Servicing Company | <input type="checkbox"/> Student |
| <input type="checkbox"/> Radio Jobber | |

- _____
 Regular Subscriber Newsstand Reader

I purchase approximately \$..... worth of radio material a month.

Name Age

Address

City State

(PRINT INFORMATION IN COUPON CAREFULLY)

Please Say That You Saw It in RADIO-CRAFT

TWO NEW **SUPREME** *Speed* INSTRUMENTS MOUNTED IN ONE COMPACT UNIT!

FEATURES OF MODEL 592 PUSH-BUTTON SET TESTER

- 1 47 Ranges and Functions
- 2 Complete self-contained—No A. C. supply needed!
- 3 Panel area only slightly more than 1/3 square foot.
- 4 Sensitive 40 microampere meter (25,000 ohms per volt)
- 5 Both 1000 ohms and 25,000 ohms per volt in SAME UNIT!
- 6 Resistance ranges to 50 meg. ALL with internal batteries!
- 7 Only TWO PIN JACKS used for ALL functions!
- 8 All ranges and functions controlled from only TWO rows of push buttons. 14 buttons control 47 variations.

MODEL 592 is an exclusive, new push-button switching circuit giving direct current range from 1 microampere to 14 amperes; 0/70 microamperes/0.7 mil./7.0 mils./35 mils./140 mils./350 mils./1.4 ampere/14 amperes.

Two D. C. voltage functions from 0.1 volt to 1400 volts in 7 ranges each! 0/3.5/7/35/140/350/700/1400 D. C. volts at 1000 ohms per volt; 0/3.5/7/35/140/350/700/1400 D. C. volts at 25,000 ohms per volt.

The Model 592 gives you from one-quarter ohm to 50 megohms—in 6 ranges. 0/500/5M/50M/500M/5 meg./50 meg. using completely internal batteries—no A. C. supply required! "Ohms short" push-button on panel allows "Zero Adjust" procedure without shorting leads together.

The 592 offers 7 A. C. voltage ranges in all—0/3.5/7/35/140/350/700/1400. Push a button and a condenser is internally connected in series with all seven A. C. voltage ranges for use as an output meter.

Finally, 5 decibel ranges—10/+6, 0/+16, +10/+26, +20/+36, +30/+46 to check the power output of any P. A. amplifier.

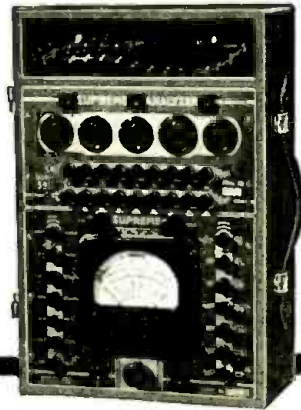

1000 OHMS AND 25,000 OHMS per VOLT!

Supreme's new instruments are **really** speed instruments. They allow you to service **more** sets in **less** time because of their easy-to-operate push-button controls. They make the servicing of sets easier, more accurate—and more profitable than ever before!

And as there are good arguments pro and con for both 1000 ohms and 25,000 ohms per volt—Supreme offers both sensitivities in one instrument... the 592! See the 592 and 593 combination at your parts jobber. You'll see why Supreme gives you more for your money than any other instruments! Mail coupon below for free literature.

Combination Price—Model 592 and 593 with case as illustrated. \$5.09 Down and \$5.09 for 11 months. **Cash Price \$5550**

FEATURES OF MODEL 593 PUSH-BUTTON ANALYZER

Due to a tremendous demand for a separate analyzer unit which can be used with any multimeter or set-tester, as well as an additional necessary unit for the SPEED-SERVICE LAB Rack and Panel, we offer the first all-push button analyzer. No more connectors and twin-jacks. Just connect your multimeter to the 593's two pin jacks, put the analyzer plug in the set's socket, the set's tube in the 593 and you can make voltage or resistance measurements between any two tube elements or current measurements in any tube elements circuit. All you do is press two push-buttons for any reading. No fuss or bother. No special instructions! It's as easy as ringing a door bell.

Two rows of special push-buttons are provided, one button in each row for each tube element. For direct current (plate, screen grid, etc.) measurements, just press both the upper and lower buttons numbered corresponding to the element. For D. C. or A. C. voltage measurements, push the upper button corresponding to the one tube element and the lower button corresponding to the other tube element between which voltage or resistance is to be measured. If meter needle backs off scale due to polarity, you merely reverse buttons. Simple, quick, practical to operate. Full instructions. Available with or without wooden tray or combination case, or as standard equipment on the complete SPEED-SERVICE LAB RACK and Panel. An ideal unit in combination case with Model 592 Push-Button Set Tester.

SUPREME SERVICE LAB RACK CONTAINING 4 SUPREME PUSH-BUTTON SPEED INSTRUMENTS!

MODEL 596 SUBSTITUTION BOX by means of nine push-buttons allows rapid, accurate, temporary replacement from 1 ohm to 50M, 100M, 250M, 500M, 1 meg.; also capacitors 0.1, 0.5, and 8 inf. Speeds up your replacement work 100%.

MODEL 592 SET TESTER with forty-seven ranges and functions—resistance ranges to 50 meg.—completely self-contained.

MODEL 594 TUBE TESTER with a new, modern tube testing circuit which utilizes the Model 592 set-tester's meter, and its GOOD—?—BAD scale. TOMORROW'S TUBE TESTER!

MODEL 593 ANALYZER unit described above.

ALL in a SPEED-SERVICE LAB RACK especially designed for these four instruments which takes up **less than one square foot** of bench space, and is only two feet high, yet houses a complete testing laboratory. Available separately, with or without portable cases.

\$8.36 Down and \$8.36 for 11 months. Cash Price \$91.25.



Supreme Instruments Corp., Dept. RC-9, Greenwood, Mississippi
 Please send me literature on your new Speed instruments.
 Name
 Address
 City
 State

SUPREME INSTRUMENTS CORP., Greenwood, Miss., U. S. A.
 Export Dept., Associated Exporters Co., 145 W. 45th St., New York City
 Cable Address: LOPREH, New York

Please Say That You Saw It in RADIO-CRAFT

A New Policy!

FREE INSPECTION PLAN — —

You can buy any Gernsback Manual on Three Days' Approval

Perhaps you're new in Radio—or probably, in previous years you missed one of the Gernsback OFFICIAL RADIO SERVICE MANUALS. This is your opportunity to buy any edition you might need—get it in a way differently than ever before offered. Under a new policy—**FREE INSPECTION PLAN**—you can buy any Gernsback Manual on Three Days' Approval. There are thirteen Manuals and books from which to choose—every man in Radio should take advantage of this privilege.

Here Is How It's Done!

Order any GERNSBACK MANUAL illustrated and described on this page—the publishers will ship it to you immediately **POSTPAID**. When it reaches you, inspect its contents. If, after three days' inspection, you decide to keep the Manual, mail your remittance to the publishers. If the volume proves unsuitable, return it postpaid.

This plan is simple—there's no mystery or red tape—it gives you every opportunity to inspect the Manual of your selection. It costs you only a few cents return postage if you decide not to keep it.

Latest Volume 7 Manual Included

Volume 7 of the OFFICIAL RADIO SERVICE MANUAL—the edition which stamped the Radio industry this past year because it was published in a new way—in twelve monthly installments, is included under this new policy. **This volume is now complete**—twelve installments, totaling 1,800 pages, are bound in a hardcover binder and just packed with information you need today—and in the years to come. The coupon below gives you the privilege of inspecting this Manual also before you buy it.

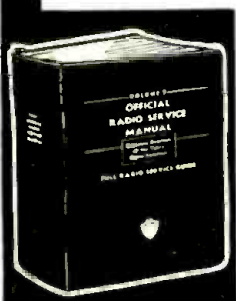

★ **VOLUME 7** ★
Newest of GERNSBACK MANUALS, contains schematic diagrams and service data on 1936-37-38 receivers. More up-to-date than any service guide published; 1,800 pages of material which radio men use every day. Wiring diagrams of over 1,200 different manufactured sets. Over 3,000 different illustrations. Bound in hard, loose-leaf covers—mechanism permits pages to be removed and replaced. Size—9 x 12 inches.
PRICE \$10.00

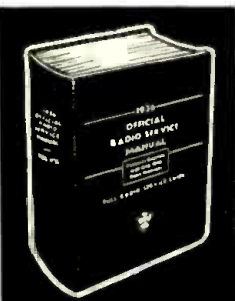

★ **1936 MANUAL** ★
Contains 1,200 pages (over 2,500 illustrations) packed with service data of 1935-36-37 sets. Diagrams of over 1,500 receivers. Shows speaker connections, power transformer connections. Alignment procedure included with diagrams. Operating voltages for over 80% of sets are recorded. Assembly diagrams show relationship of separate units to each other. Size—9 x 12 inches; hard cover, looseleaf binder.
PRICE \$7.00



★ **1935 MANUAL** ★
An authentic radio service guide of over 1,000 pages with more than 3,000 illustrations—contains schematic diagrams of 1934-35 receivers. Features many old sets never previously described, early all-wave and short-wave sets, auto-radios, midset and cigar-box receivers. Includes data on P.A. amplifiers, servicing instruments, tube information and **FREE QUESTION AND ANSWER SERVICE**. Size—9 x 12 inches; flexible, looseleaf covers.
PRICE \$7.00

★ **1935 AUTO-RADIO MANUAL** ★
OVER 240 PAGES
OVER 500 ILLUSTRATIONS
Looseleaf Binder—Flexible Covers
PRICE \$2.50



★ **1934 MANUAL** ★
Contains over 400 pages—over 2,000 illustrations. The schematic diagrams cover 1933-34 receivers. Features voltage readings, I.F. transformer values in superhets, valuable tube data and **FREE QUESTION AND ANSWER SERVICE**. A handy index makes it easy to find any information on service problems. Master index includes diagrams published in previous MANUALS. Size—9 x 12 inches; flexible, loose-leaf covers.
PRICE \$3.50



★ **1933 MANUAL** ★
This 700-page Manual, with over 2,000 illustrations, contains page after page of operating notes—schematics showing location of parts on chassis—values of I.F. peaks, resistors and condensers. A complete section on construction of various types of test equipment, plus money-making ideas for radio men. Includes auto-radio installation and servicing. Size—9 x 12 inches; flexible, loose-leaf covers.
PRICE \$5.00



★ **1932 MANUAL** ★
This Manual contains a full radio service guide of 1931-32 receivers. With over 1,000 pages and over 2,000 illustrations, it features a step-by-step analysis in servicing a receiver—chart showing operation of vacuum tubes—schematic diagrams with color coding indicated—commercial short-wave receivers and adapters and servicing public address equipment. Size—9 x 12 inches; flexible, looseleaf covers.
PRICE \$5.00

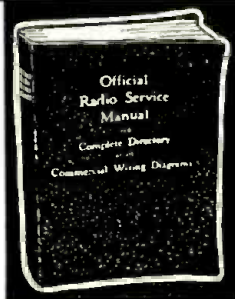

★ **1931 MANUAL** ★
The first of the famous GERNSBACK MANUALS—contains all available wiring diagrams of nearly every receiver manufactured since 1927, and many prior to that year. This particular edition contains 650 pages (including supplements) with over 1,500 important diagrams. Most valuable to radio men is the **RADIO SERVICE COURSE** published in this edition. Size—9x12 inches; flexible, looseleaf covers.
PRICE \$4.50
including supplements.



OFFICIAL RADIO SERVICE HANDBOOK
Here's the sensational book on servicing. Covers over 500 topics. Contains a special section of 250 pages of Operating Notes. The book covers: Circuit Theory and Analysis; Modern Servicing and Test Equipment; Practical Trouble Shooting; Specialized Receiver and Installation Data; Modernization and Conversion Data, etc. Over 1,000 pages—over 1,000 illustrations; hard covers, Size 6 x 9 inches.
PRICE \$4.00

● This Policy Includes —

- OFFICIAL REFRIGERATION SERVICE MANUAL (Volume 1) — \$5.00
- OFFICIAL REFRIGERATION SERVICE MANUAL (Volume 2) — \$5.00
- OFFICIAL AIR CONDITIONING SERVICE MANUAL — \$5.00

How To Get Any Manual You Need!

After you have definitely decided which Manual you want, fill in completely the coupon at the right. Clip it to your letterhead or paste on a penny post card and mail to the publishers. In a few days your Manual will reach you—Don't lose time—send coupon, TODAY, to

RADCRAFT PUBLICATIONS, Inc.
99 Hudson Street New York, N. Y.

RADCRAFT PUBLICATIONS, Inc. RC-938
99 Hudson Street, New York, N. Y.

Please send me, **POSTPAID**.....for three days' examination on approval. In three days I will remit to you the full cost of the Manual or book selected, or return the volume to you postpaid.

Name
Address
City State

Name of company or employer
(This offer is good only in continental United States.)

Please Say That You Saw It in RADIO-CRAFT



' ' T A K E S T H E R E S I S T A N C E O U T O F R A D I O ' '

SCHOOL-ROOM BROADCASTING

By the Editor — HUGO GERNSBACK

ONE of the most fertile fields for the Radio Industry and, particularly, the service and installation trade, is a new radio branch which, for want of a better name, might be termed *School-Room Broadcasting*. A special feature article in this issue of RADIO-CRAFT makes the point clear.

There is no need to argue about radio's popularity with school-children, as a whole. Indeed there are probably no greater radio enthusiasts than today's school-children. The children have more time than grown-ups and many radio broadcasts are directed particularly to children. Indeed, when it comes to radio programs the children usually know far more about them than grown-ups.

Naturally the children are interested in everything that has to do with radio broadcasting—not only from a listening view-point, but from the transmission end as well. There is hardly a town which does not have a radio broadcast in which children appear regularly every week. The children may be highly talented but frequently they are not. Children take quickly to microphone technique and there are few youngsters now-a-days who do not imitate some of the radio stars in one way or another.

For this reason the attempt that has been recently made to install regular broadcast studios in the school-rooms is highly commendable because there is no question that sooner or later this new endeavor may well grow to tremendous proportions.

Of course, not every school-room will be hooked up immediately to a radio station in order to broadcast the pupils' talents over the air, as is for instance being done now in a Brooklyn, New York, school; but whether the broadcasting goes over the air or not, is not so very important. The main thing is that children will be trained in microphone and broadcasting technique and the incentive which this gives the children is a tremendous stimulus not only to their imagination but will bring out hidden talents of the pupils. This will make the pupils work harder to adapt themselves for broadcasting technique and we would not be surprised if many future radio stars will have their inception in such School-Room Broadcasting.

If the transmitter is not hooked up with a radio station the pupils' voices, can, of course, be recorded on a phonograph disc or the other pupils can listen, in a near-

by auditorium, to the broadcast. In this manner—when the children take turns by alternately broadcasting and listening, their own technique is quickly improved and they will know soon what to do and what to avoid and how to get the best effects in broadcasting technique.

To the Radio Industry, School-Room Broadcasting opens up an entirely new and really tremendous field. To be sure, it will not be possible to immediately install complete broadcasting studios in every school house. Yet the larger schools, of which there are thousands throughout the country, will be an immediate and lucrative field to the industry.

Every wide-a-awake Serviceman who knows Public Address and Sound should have little difficulty in making sales in his locality. Incidentally, these school broadcasting studios run into considerable money and will net a very decent profit to the enterprising man who goes after this business.

It is also true that it is quite possible to start a school off with a small beginning and keep on adding equipment as time goes on. In other words, those schools which have not a full appropriation for a complete broadcasting studio can start on a small scale with a small unit and keep on adding to it as time goes on. This is of advantage not only to the School Board but to the Serviceman as well, because expenditures can be stretched over a period of time and new equipment can be added as funds warrant expenditures.

The important point to consider is that once one or more schools in a locality have taken up School-Room Broadcasting, the others will probably follow in due time because of the pressure of the pupils on the school, which will probably be great enough to convince the school authorities that such radio installations are not only worthwhile but are necessary from many different standpoints.

Soon no doubt there will be keen broadcasting "tournaments" not only between the different schools but between different towns to bring out the best talent. Not only can latent talent be brought out much quicker and better by such competitive means but talent which otherwise would never have come to light at all. School-Room Broadcasting affords deserving young boys and girls an opportunity for self-expression never before available.

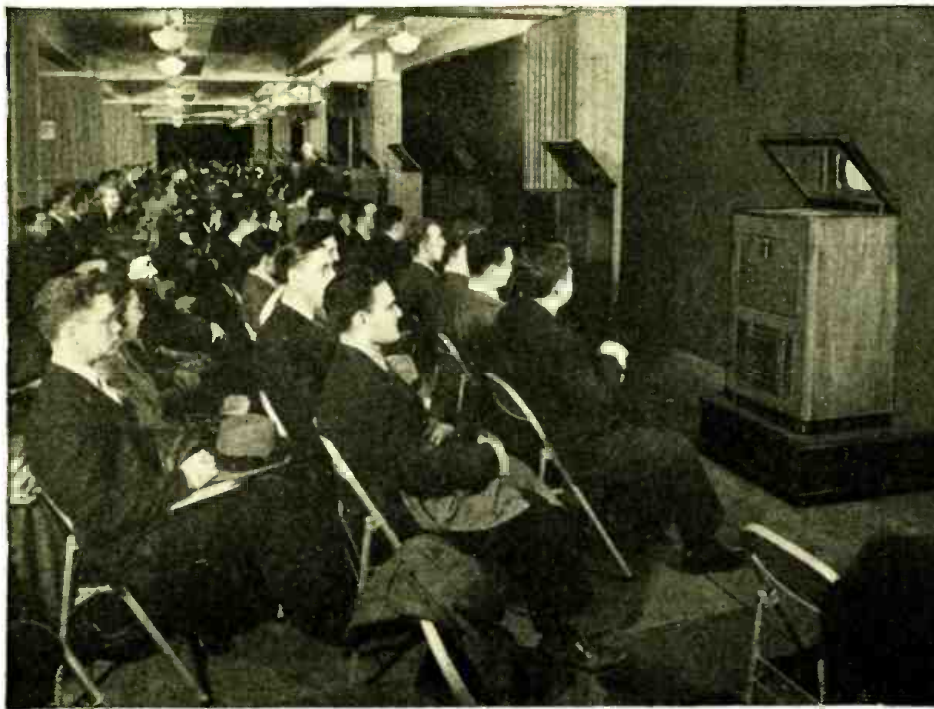

VIDEOISED TRAGEDY

THE epic wire-televising of Marion Perloff, 28, as she hurtled to a suicide's death on the pavement of Rockefeller Center, N. Y. C., at press time last month, from the 11th floor of the Times and Life Building in the Center, went unviewed by lookers-in!

The pick-up trailer of an N.B.C. mobile television unit, parked for 3 days alongside the Sunken Plaza, was connected only by coaxial cable to studio receiving equipment on the 3rd floor of the RCA Building. Engineer Ross Plaisted at the trailer's Iconoscope-camera focused-in the scene as the girl's falling body caught his eye. Hearing the sound (which had been sharply focused-in by a *parabolic microphone*) of the body as it landed, vice-President O. B. Hanson and 2 assistants at the receiving Kinescope in the studio viewed the scene immediately afterward—clearly saw and heard the gathering crowd.

TELEVISION

COMMENTING upon the use of television as a medium of classroom instruction, as described last month in *Radio-Craft*, Dr. James Rowland Angell, N.B.C. educational counselor and former President of Yale University, remarked optimistically (to 200 N. Y. University students before 15 television receivers, on the 62nd floor of the RCA Building, 14 of which are shown in the photo above): "We regard the possible uses of television in connection with educational work as *literally unlimited*."

Within the range of major television transmitting stations now licensed by the Federal Communications Commission, there are 20,000,000 potential viewers, according to radius surveys said to have been conducted last month by American Television Corp.

A full-length talkie went on the airways last month. Listeners and lookers-in over a radius of more than 40 miles from mid-Manhattan followed the dramatic action of Alexander Korda's production, *The Return of the Scarlet Pimpernel* (historical adventure thriller).

The first full-length film ever to be televised in this country, according to N.B.C., the Korda production was selected to ascertain program suitability of such material, and whether such shows are capable of holding an audience's attention for the 1½ hours of its run.

(How would viewers react if sponsors insisted on ad-blurb interpolations?)

THE RADIO MONTH

Susan and God was the vehicle for television's maiden entrance into the legitimate drama; a 25-minute bedroom setting (!) from the stage play was televised at N.B.C.'s Radio City studios, last month.

Copies of the stage setting were built special at Rockefeller City, and spectators who had seen the theatre production pronounced the television show as real as looking over the footlights, the *N. Y. Times* stated.

Before suspending "official" transmissions for the summer, so to speak, N.B.C./RCA technicians made an outstanding contribution to television progress in presenting—5 times in one day to invited audiences—the art's first completely-own, flesh-and-blood show: *The Mysterious Mummy Case*.

This 25-minute "mellerdrammer" was written by Thomas Hutchinson especially to meet the specialized requirements of television show production technique, and was directed by him. Production was supervised by C. W. Farrier; engineered by R. R. Beal and O. B. Hanson.

Presentation calls for swift costume changes, perfect delivery, spot change of 5 sets, proper blending of travelog material from another floor, and numerous shifts of iconoscope-camera angle and focus shots. Television, you know, permits neither "retakes" to correct errors, as in talkies, nor "intermissions" for scene-shifting, as in legitimates.

As perceived by the eye, reception fidelity exceeded that indicated by the photo (of a scene) on pg. 135; the brain gets an averaged impression. Show-



The Planets, radio's first full-hour experiment in poetic form, utilized Hayden Planetarium as its "atmosphere" for 30 actors. In N.B.C.'s studio 3B, 30 blocks away, a 75-piece orchestra and sound effects were properly cued-in! Four members of the cast in Alfred Kreyborg's drama here have the Planetarium's Zeiss projector as background.



Susan and God experiments marked "the first time in television history that a current Broadway hit with its original cast" went on the air in New York. An audience of 35 guests watched the play on the screen at Radio City, while others looked-in at 70 official observation posts within a 50-mile radius. Gertrude Lawrence and Paul McGrath are shown, above, "emoing." Producer John Golden feels television will help the theatre.

"STORY OF GETTYSBURG"

INDEPENDENCE DAY this year fell within the week dedicated to the 75th Anniversary of the Battle of Gettysburg. Technifacts, special to *Radio-Craft*, follow, regarding N.B.C.'s June 30 to July 3 mammoth program built around this event which included networking the "Story of Gettysburg" drama (June 30, July 1), and Pres. Roosevelt's Peace Memorial dedication.

Set-up included: (1) cue transmitter and main control room at Glatfelter Hall, Gettysburg (Pa.) College, and mikes—a parabolic for band music—in the Stadium for parades, concerts, speeches; (2) a second cue unit (an ultra-H.F., 25-watt type, like the Hall's, but mobile) for the Stadium programs; and, (3) individual 2-watt pack sets at the Blue (G.A.R.) and Gray (U.C.V.) Veterans' encampments (their last reunion), ¼-mile from the Hall, as pictorially diagrammed at right.

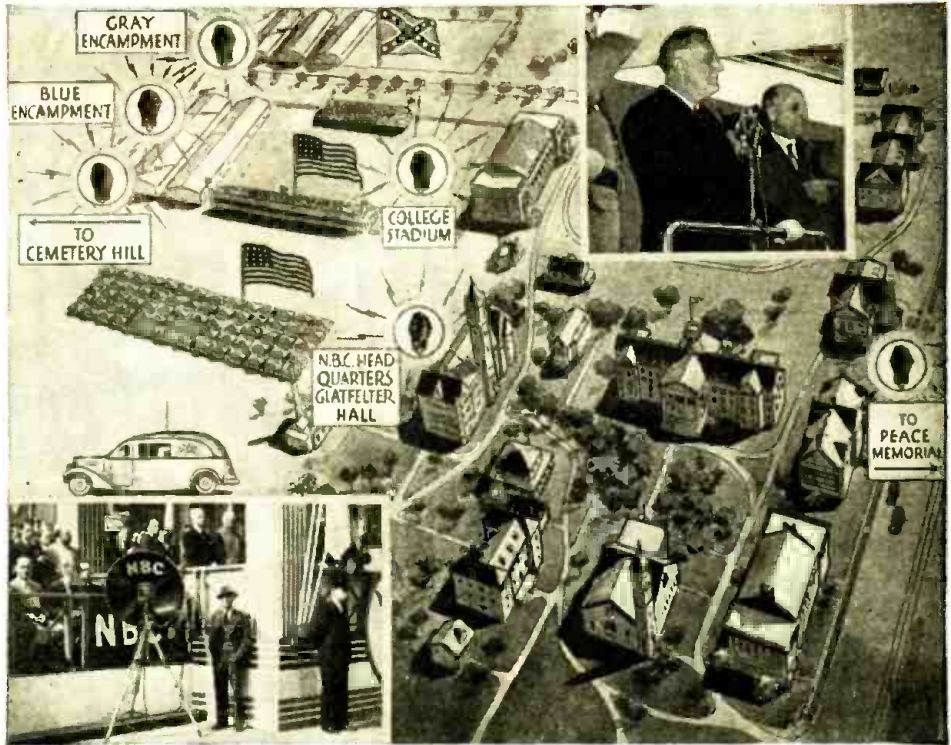

IN REVIEW

manship and technique were excellent. London to Middlesbrough (Yorkshire), was spanned last month by clearly-received television images from Alexandra Palace, it was reliably reported. Wavelength, 6.67 meters; distance, 220 miles!

The Lancet, authoritative London magazine of the English medicos, remarks (with presumably no attempt to pun the word we impishly quote!):

"A rather delicate situation arises out of rival claims to the capacity of the 'ether' to serve 2 masters. One is the public which has to be amused, or instructed, or perhaps advised of catastrophe by means of signals sent by way of certain wavelengths. The other is the electrologist who has a claim, *prior both in time and intent*, on these same wavelengths" for diathermy treatment.



The Mysterious Mummy Case, as viewed on the mirror of a television receiver located at Westport, Conn., 45 miles from the Empire State Building in N. Y. C. Tom Terriss is shown examining the wares of an Arab antique dealer in his Cairo Shop. Several complete images were reproduced during the fraction-of-second exposure this photograph required; it is shown here unretouched. Image (snapped by N.B.C.'s O. B. Hanson) was 10x7½ ins. high!

BROADCASTING

HAYDEN Planetarium was chosen for the broadcast of *The Planets* to provide a realistic setting for the spoken parts of the play, last month. The story told of an old astrologer peering into the heavens in search of peace and encountering the planetary gods, Mars, Venus, Mercury, Jupiter, Saturn, Uranus and Neptune, roaming the earth as in Grecian times and each controlling a phase of the earth's activities. The problem of mixing the vocal portion of the program from the Planetarium, with the orchestral and sound effects in N.B.C.'s studio downtown, was solved by telephoned cues, and monitoring in the studio.

The 2nd annual Paley Amateur Radio Award went to Robert T. Anderson, of Harrisburg, Ill., last month, for valiant service rendered during the

January, 1937, flood emergency in the Ohio River valley. Largely through his efforts, and with only 10 hours' sleep in 4 days, all 1,500 of Shawneetown's inhabitants were rescued.

No matter what you do, some listener is bound to take offense, N.B.C. prexy, Lenox R. Lohr, commented last month (vide *Variety's* "Radio Section").

"We are called 'fascists' when Hitler or Mussolini speak over our networks. We anticipate the label 'Communist' or 'Socialist' when Earl Browder or Norman Thomas comes before our microphones. We are 'capitalists' when the representative of some corporation speaks; 'pro-labor' when the American Federation of Labor or the Committee for Industrial Organization broadcasts," the network head related. "We are 'radical' and 'conservative' and 'liberal' by turn, and, in view of some, may even appear 'patriotic' and 'subversive' at the same time."

But there's some solace in public reaction. Contradictory criticisms "at least indicate we are keeping a fair balance," he added.

Strange, the pattern that fate weaves into the warp and woof of destiny. Hyman Leiderman, 16, was at the point of death in Kings County Hospital (Brooklyn, N. Y.) from a streptococcus viridens infection. An appeal by his mother to a Canarsie radio amateur for a blood donor by someone who had survived the disease was picked up and passed on by other radio amateurs, finally to reach station WCLS in Joliet, Ill., where it was re-broadcast on the longer wavelength. Mrs. Eugene Koehl of

(Continued on page 182)



A complete amateur sending and receiving station, in a simulated ham shack, was operated from the Perroquet Suite of the Waldorf-Astoria (where William S. Paley, President of C.B.S., gave his annual Amateur Radio Award), N.Y.C., for 2-way contact with hams throughout the U.S. Award-winner Anderson and historic station, above.

"ELECTRONICS"—A CAR MAKER'S GENIE

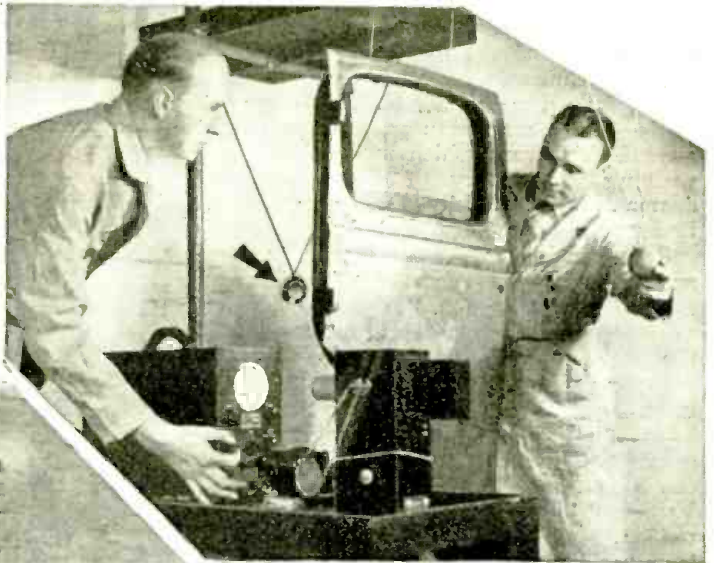

↑ **EVEN** before television moves out of the experimental laboratory some of its basic principles are being applied to influence the design of new model automobiles. Plymouth engineers first employed cathode-ray-tube apparatus last year, for acoustical studies to develop new kinds of sound-proofing materials for cars. The 1938 Plymouth, as a result, has many refinements. As shown above, cathode-ray tubes, slightly smaller than the latest television types, are employed in these tests. Through their use, Floating Power has been perfected. The new science is credited with the removal of one of the chief sources of motor fatigue—vibration. Five new sound-proofing materials have been developed—affording the much-advertised "hushed" ride.

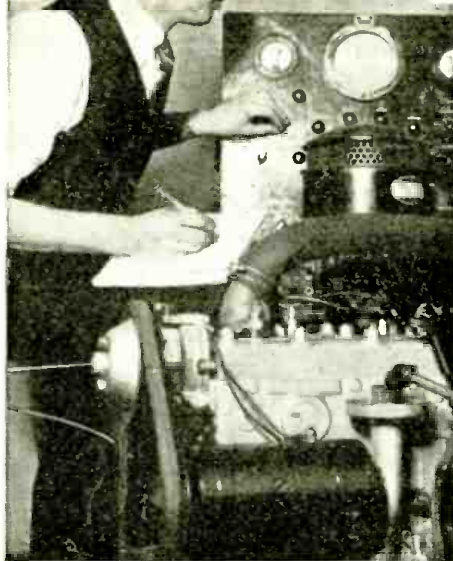

↑ **A** HEAVY steel ball when swung against the door panel produces sound which is picked up by the microphone (arrow) behind. The sound-image appears on the screen of the oscilloscope and is photographed by the camera shown in front of it. Various sound-dampening materials inside the door are thus tested. Other car-parts undergo similar tests.

← **C**ATHODE-RAY apparatus permits the study of torsional vibration in the crankshaft, driveshaft, transmission and other vital parts. The image on the face of the cathode-ray tube is a magnification of the vibration 10,000 times. Engines on the testing block are run for 50 hours at 4,000 r.p.m. and 20 hours at 4,500 r.p.m.—equivalent to the wear and tear of 3½ years of Indianapolis racing. A record of the vibration before and after this test then tells the story of motor wear.

↓ **D**IFFERENT roads make different noises! And different parts of a car have different vibrations, too. Microphones and noise-level indicators placed everywhere inside the car ferret out the slightest noise. Converted into electrical energy, these noise vibrations appear in the form of waves on an oscilloscope and are photographed on film as shown below in the insert. This permits leisurely study of the causes and remedies for vibration.

↓ **S**OAKING up noise from the air! Insulating materials are tested in this special concrete tunnel. Noise must be actually "soaked up" by the sound-proofing material in this test before they are accepted for use in the cars. The new sound-proofing materials finally accepted and used in the car are said to produce a remarkable kind of driving quiet, in which it is possible to hear a watch tick!





WAR GAME!

Fictitious enemy "Black" forces attacking our Atlantic coast were repulsed by Army "Blues." Broadcast stations aided in the Farmingdale (L. I.) "blackout."

R. D. WASHBURNE

WAR exists between the United States and a coalition of Asiatic and European powers. Far out on the Atlantic a naval force of these powers is escorting troop transports and aircraft carriers for the purpose of effecting a landing on the New England coast. Another force, with even more planes, has just left Europe, probably headed for Virginia. What are the best defense measures to take?

THAT'S the problem the Army put to its Air Force early last month, calling upon it to organize, on the ground and aloft, a line of defense which would frustrate this attack. Just to make the "poser" a real "quadratic" the Army strategists left the Navy's Fleet in the Pacific, fully occupied with defensive operations there and unable to lend any very heavy support.

G.H.Q.

Under the command of Major General Frank M. Andrews, the first measure of the Air Force was to set up General Headquarters at Mitchel Field, with subsidiary air bases so located that their planes were able to push defensive operations along the coast from Maine to Georgia. Having settled upon this ground plan, General Andrews then put the Air Corps into the air *en masse*. Pursuit, attack and bombardment planes took off from California, Texas, Louisiana and airfields in between, laden with men and baggage—3,150 men and 3,000,000 lbs. of baggage—in the most elaborate concentration by air that the Army has ever staged.

The succession of military events of the 7-day mimic warfare would ordinarily occupy at least a month in the waging of an actual war. Radio of course played an essential part in the maneuvers, but almost exclusively as a means of contact with airplanes and remote points which could not be contacted by wire lines. Where wire contact was physically possible radio communication facilities were subordinated to the extensive, effective and speedy operations of a teletypewriter network comprising 45 of the latest-type combination sending and receiving machines linking the temporary airforce headquarters of Mitchel Field with 17 other air bases scattered from Massachusetts to Maryland.

Bell System and American Tel. & Tel. engineers provided and installed within a month from receipt of the Army's order the hundreds of miles of wire and the emergency telephone, radio, broadcasting and teletypewriter equipment. It is interesting to note that during the maneuvers magnetic

(Continued on page 167)

Above, an Army XB-15 or Boeing "Super"—Flying Fortress on view at Mitchel Field. Below, C.B.S.'s John King is all set to tell the United States and South America what it's like to witness a War Game "blackout."

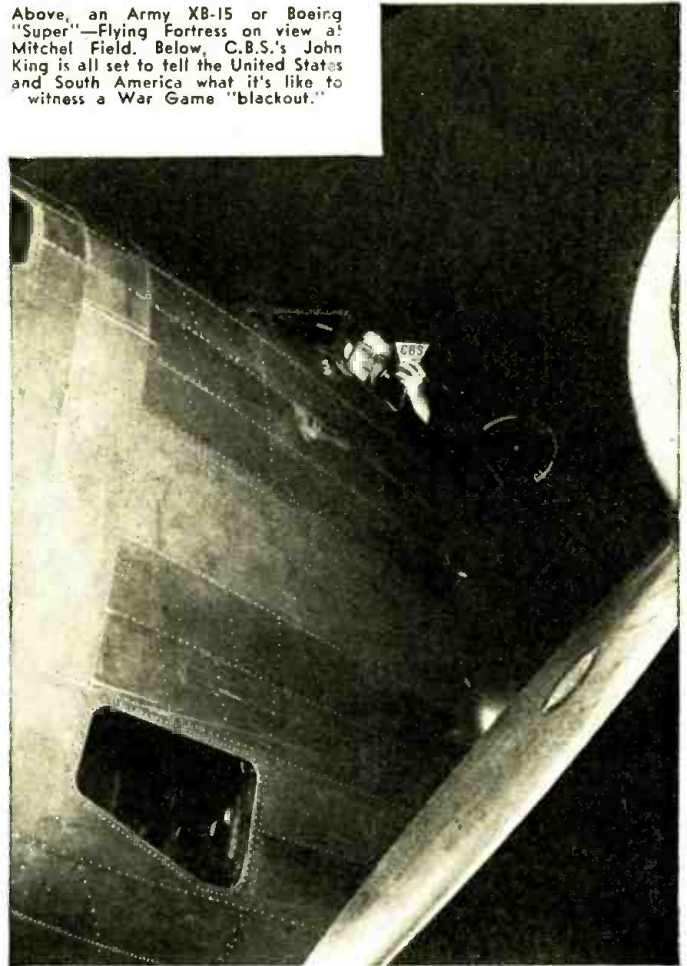

Sergeant D. P. Ancoin at Mitchel Field helped coordinate land and air radio facilities. Weather reports, for instance, received by teletypewriter were relayed to the air armada.

Servicemen!

Servicemen!

Servicemen!

BUILD THIS 38-RANGE

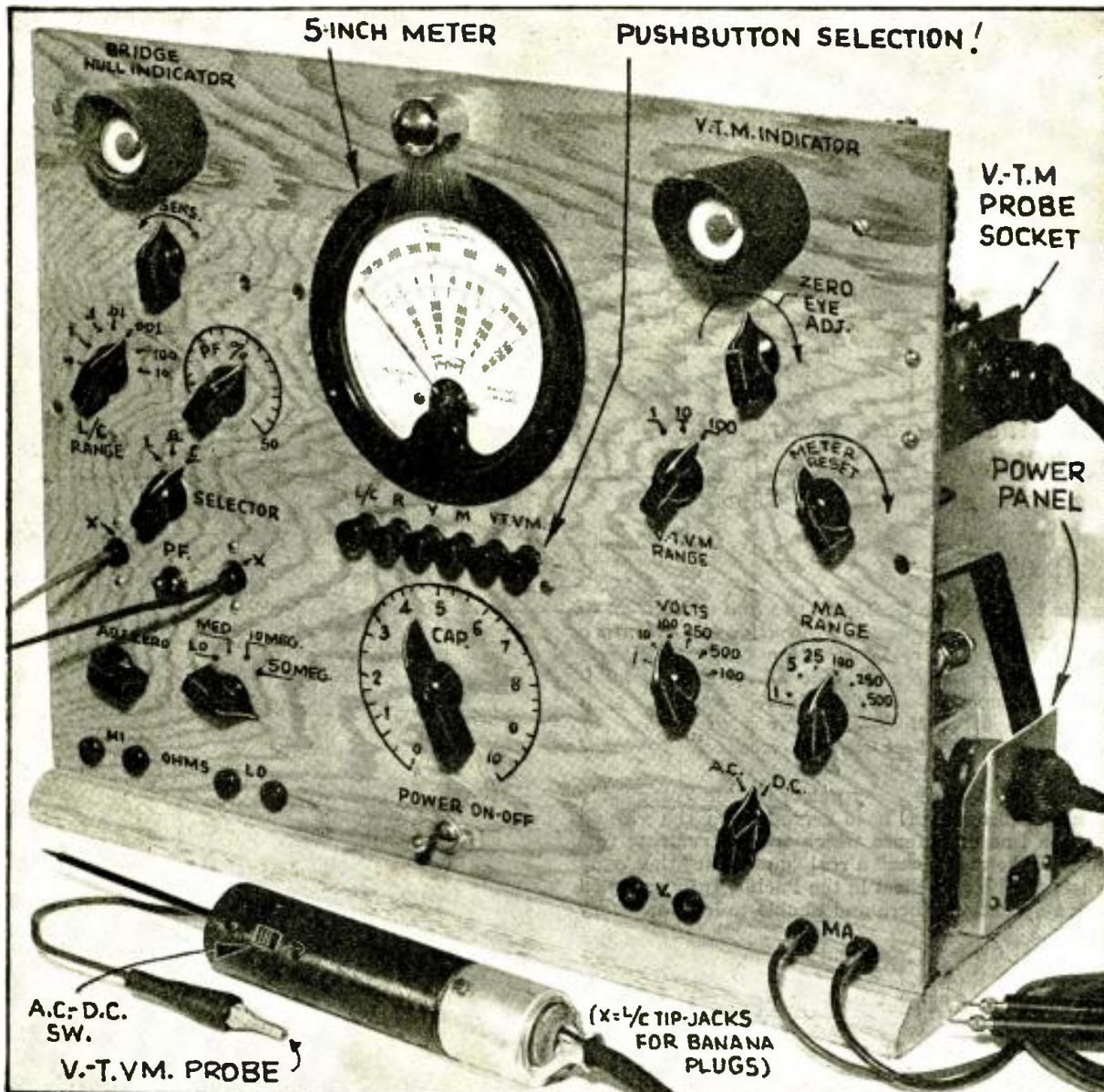

Fig. A. This instrument combines the functions of (1) A.C.-D.C. voltmeter, (2) A.C.-D.C. milliammeter, (3) Ohmmeter, (4) Capacity bridge, and (5) Peak V.T. voltmeter. Whether breadboard-mounted for economy or dressed in engraved bakelite panel it's still a knockout!

IT'S A PRACTICAL INSTRUMENT

because:

- it uses only 1 meter, a rugged 1-ma. movement with volt-ohm-milliamper scales on a 5-inch face.
- each meter function is controlled by a pushbutton circuit-selector switch.
- it has individual range switch and tip-jacks for each separate meter function.
- it uses a Wheatstone bridge circuit for measuring capacity, inductance and resistance, utilizing a vacuum-tube amplifier stage and tuning eye as null (or balance) indicator;—60 cycle input.
- it incorporates a peak V.-T.V.M. circuit using 1-ma. meter and tuning eye. It is self-calibrating and therefore not affected by the changing of tube characteristics due to aging; draws no current from measured source; input tube is at end of extension cable.
- a total of 38 ranges is available for all practical servicing work.
- the entire meter is A.C.-operated except the low-range ohmmeter which uses a single 1.5-volt cell.
- A.C. volts and A.C. milliamperes are rectified through an 83 mercury tube rectifier; A.C. voltmeter readings are compensated for, by capacity shunts on "Volts" multiplier thus doing away with stagger markings on dial scale.
- it incorporates the following meter ranges and functions:
- VOLTS—A.C. and D.C.: 1, 10, 100, 250, 500, 1,000 volts; Peak V.-T.V.M.—1, 10, 100 volts.
- Milliampere—A.C. and D.C.: 1, 5, 25, 100, 250 and 500 ma.
- OHMS: 0 to 500 ohms, shunt-type circuit and slide-back reading with 9 ohms at center of scale (First division is 0.2-ohm); 0 to 100,000 ohms, series-type circuit (1.5-volt cell); 0 to 10 megs. (using 150 volts from power supply); 0 to 50 megs. (using 750 volts from power supply). Dual potentiometer for single-knob adjustment of zero-ohms.
- CAPACITY: (1) 10 mmf. to 100 mmf.; (2) 100 mmf. to 0.001-mf.; (3) 0.001-mf. to 0.01-mf.; (4) 0.01-mf. to 0.1-mf.; (5) 0.1-mf. to 1.0 mf.; (6) 1.0 mf. to 10 mf.; (7) 10 mf. to 100 mf.
- INDUCTANCE: seven ranges, from 100 micro-henries to 100 henries.

Servicemen!

Servicemen!

Servicemen!

"PUSHBUTTON" BENCH TESTER

Pushbuttons here afford in an ultra-modern test instrument the speed and convenience they supply in tuning modern sets.

CHARLES SICURANZA

PART I

THE development of this instrument was prompted by a desire to incorporate all the best features of separately available units, which are a necessity in present-day service, into 1 compact unit.

The complete tester as shown in the photograph (Fig. A) is a compact grouping of instruments, comprising an A.C.-D.C. Voltmeter, A.C.-D.C. Milliammeter, Ohmmeter, Capacity Bridge and Peak Vacuum-Tube Voltmeter, all operated by a common power supply.

While this tester was designed expressly for bench use by experienced Servicemen, the various functions of the tester, once grasped, will enable even the beginner or casual experimenter to operate the tester without confusion, since there is only one meter to read and only one function can be selected at one time.

PUSHBUTTONS SELECT "FUNCTION" AND "RANGE"

Launching into a discussion of the 5 major functions, we see from the photograph, Fig. A, that a modern pushbutton switch assembly is used as a Function Selector and rotary switches are used as Range Selectors.

Thus, to read D.C. voltages, the first operation is to press in the selector button marked V which automatically breaks all other circuits and places the meter in series with the high-precision Volts Multiplier and Volts Range switch. The voltage range is from 1 volt to 1,000 volts in 6 steps.

To read A.C. voltages, 2 additional operations are required; first, the power supply is switched on and then the A.C.-D.C. switch is turned to the A.C. position. A break-down circuit of the A.C. Volts position is shown in Fig. 1A. Note that a mercury-vapor rectifier type 83 is used to convert the A.C. measured volts to D.C. for the meter. The 83 was

chosen as a rectifier for several reasons:

- (1) Comparatively inexpensive.
- (2) Used to provide high voltage for Ohmmeter.
- (3) Used as *alternating current* rectifier to enable current readings with the D.C. meter.
- (4) Low internal voltage drop.

In order to provide an A.C. reading of r.m.s. value which would coincide with the D.C. scale calibration, a capacity network is shunted around the Volts multiplier. This arrangement gives readings which are correct to within 10 per cent averaged over 4 ranges, excluding the 1 and 1,000 volt ranges.

MILLIAMMETER OPERATION

To read D.C. ma., press in the selector button marked M and choose the desired range from 1 ma. to 500 ma. on the Range switch. For the beginner's sake we must point out that the milliammeter should *never* be placed *across* any circuit. Always *break* into one side of the circuit and connect the meter in series at the break.

To read A.C. ma., it is necessary as before, to turn on the power supply and turn the A.C.-D.C. switch to A.C. Since no compensation is used across the high-precision shunts, it is necessary to multiply the meter reading by the factor 1.66 to obtain the r.m.s. value of current. Thus, a reading of 300 ma. on the meter, indicates there is actually a flow of 498 ma. in the circuit. However, it is well to note that this pulsating current is sufficiently powerful to demagnetize the permanent magnet in the meter if the test is prolonged for more than 2 minutes.

Therefore, high alternating current tests should be performed as quickly as possible. Due to contact potential in the 83 rectifier, there is a constant current of more than 1 ma. flowing through the closed circuit which makes it imprac-

tical to read A.C. values lower than 5 ma. The break-down circuit of Fig. 1B shows the action.

OHMMETER OPERATION

Special attention was given to the ohmmeter circuit to insure high accuracy over long periods of service. Ohmmeter service is selected through button R and 4 ranges are provided, 2 of which are battery-operated with a 1.5-volt flashlight cell. Of the 2 calibrated scales on the meter dial the upper is for the series type, while the lower is for shunt connection, of the *slide-back* type. The shunt connection is extremely useful for reading very low resistance values, as the first marking on the dial is 0.02-ohm. The center of the scale reads 9.9 ohms. The medium resistance range is from zero to 0.1-megohm, battery-operated.

In order to use the 10-megohm and 50-megohm ranges, the power supply should be turned on and the A.C.-D.C. switch turned to D.C. In this circuit the 83 rectifier supplies 750 volts and 150 volts.

The dual ohmmeter zero adjuster provides single knob operation for all 4 ranges. Note that when the range switch is set on LOW ohms, a shunt circuit is formed which is independent of the meter. A current of 10 ma. flows through this circuit regardless of whether the meter or external resistances are connected or not. Therefore, it is possible to discharge the 1.5-volt cell unknowingly if the range switch is allowed to remain on the LOW tap for long periods. It is best to leave the range switch on any of the other 3 taps when the LOW range is not actually required. Break-down circuits of the 4 ohmmeter ranges are given in Fig. 1C.

PEAK VACUUM-TUBE VOLTMETER

Of all the different types of vacuum-
(Continued on following page)

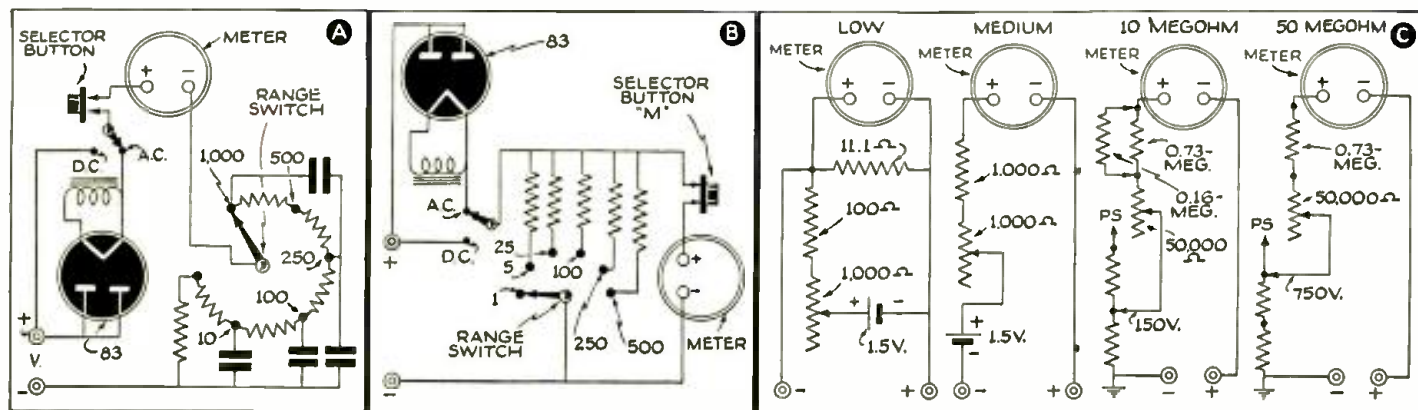

Fig. 1. Details of (A) the A.C. voltmeter circuit, (B) the A.C. milliammeter circuit and (C) the 4 ohmmeter ranges.

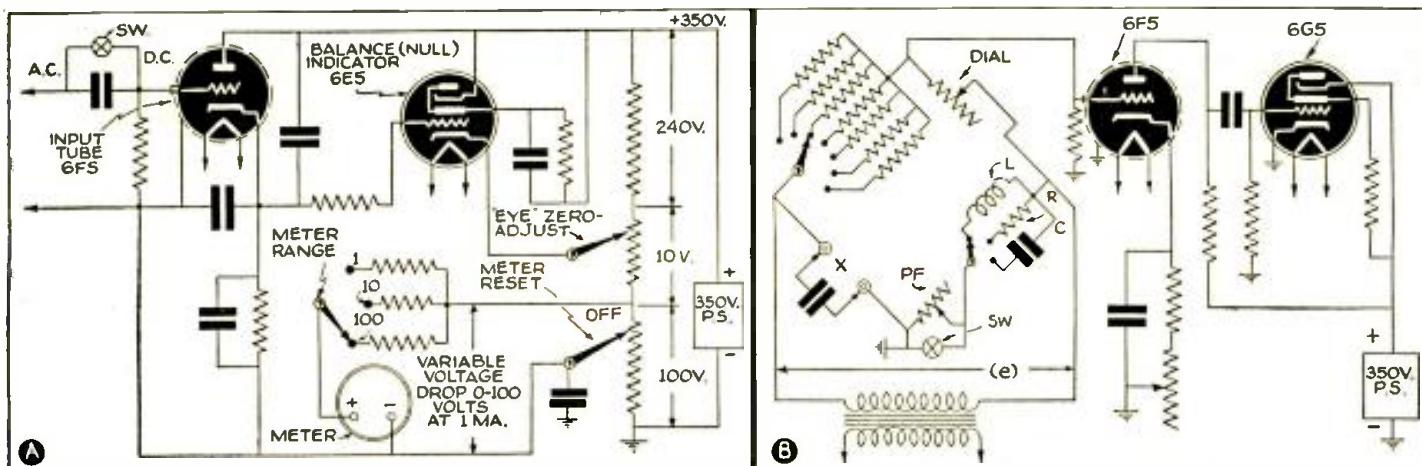

Fig. 2. Schematic circuit of (A) the vacuum-tube voltmeter and (B) the capacity bridge. In both circuits a visual "eye" indicates when the bridge circuit is balanced.

(Continued from preceding page)

tube voltmeters, the most useful from a Serviceman's point of view is the peak type. The circuit used in this tester utilizes a "tuning eye" and the D.C. voltmeter with ranges of 1, 10 and 100 volts. The circuit has been used in one form or another for several years and has been proven to give dependable and highly accurate results.

To operate the V.-T.V.M., perform the following operations in the order given:

- (1) Plug the detachable probe and cable assembly into the octal socket on the upper-right-side of the tester panel.
- (2) Set the METER RESET knob to OFF at its extreme counterclockwise position.
- (3) Press in both buttons marked V.-T.V.M. at the same time.
- (4) Turn on the power supply and wait until the 6E5 glows green.
- (5) Short together the probe and clip at the tube end of the cable.
- (6) Adjust the shadow width of the 6E5 until there is the barest trace of an opening.
- (7) Set the meter range to 100 volts if the source to be measured is unknown and to 10 or 1 if the voltage is known to be within these ranges.
- (8) Push the thumb switch on the probe handle to A.C. or D.C. depending on the source to be measured. If the source is unknown leave the thumb switch at the D.C. position.
- (9) Remove the short at the probe tip and apply both the prod and clip across the source to be tested. The eye shadow will now open a certain amount.
- (10) Turn the meter RESET knob slowly clockwise until the eye shadow closes again to its former position.
- (11) Read the result in peak A.C. or straight D.C. on the meter scale.
- (12) If the meter goes off-scale before the eye is fully closed, switch to the next higher range. If this happens on the highest range, then the voltage to be measured will have to be broken up (if feasible) by the voltage divider method.

Please note that the A.C. voltage reading is higher than the usual r.m.s. reading. Merely divide the meter reading by 1.4 to obtain the r.m.s. value.

For example, when the meter reads 42 volts, the r.m.s. value is 30 volts. Another characteristic of such meters is that the indicating device stands still at the preset point and will not follow variations of input voltage. However, if voltage variations of a slow nature are present, they may be observed by the opening and closing of the tuning eye and followed by turning the reset knob. The break-down circuit is shown in Fig. 2A.

WHEATSTONE BRIDGE CIRCUIT

This circuit uses no meter. When the condenser under test is in balance with the bridge, the 6G5 tuning eye will open. In order to operate the bridge circuit:

- (1) Turn on the power supply.
- (2) Press in the selector button marked L-C.
- (3) Wait until the 6G5 glows green.
- (4) Turn the L-R-C knob to C and insert the banana plug cords into the 2 jacks.
- (5) Turn the range switch to the range that you think the condenser may match.
- (6) Turn the bridge balance knob until the "eye" opens as far as possible. If the eye will not open, try a higher or lower range.

Since the taper of the balance potentiometer is linear and the dial scale (not shown in photo) is calibrated in 10's from 0 to 100, it corresponds quite accurately with the capacity of the condenser under test. For example, on range No. 4 which is marked 0.01- to 0.1-, the dial scale readings would be 10 for the 0.01-mf. condenser and 100 for the 0.1-mf. condenser. Similarly, on range No. 5 a 0.25-mf. unit would read 25 while a 0.5-mf. unit would read 50.

The power factor percentage reading is obtained by closing the toggle switch and then turning the Power Factor knob carefully until the eye opens again as far as it will go. An approximate range of from 0 to 50 per cent is afforded by this control. The break-down circuit of the bridge is shown in Fig. 2B.

Constructional details of the tester will be given in the October issue. The complete List of Parts is given now to enable builders to obtain the required material in the meantime.

LIST OF PARTS

One power transformer, for 5-tube set with 6.3 V. tubes, P.T.1;
Two filter chokes, 20 henry, 200 to 400 ohms, Ch.1, Ch.2;

RESISTORS

One I.R.C., type BT $\frac{1}{2}$, $\frac{1}{2}$ -W., 2 megs., R1;
One I.R.C., type BT $\frac{1}{2}$, $\frac{1}{2}$ -W., 1 meg., R2;
One I.R.C., type BT1, 1 W., 1000 ohms, R3;
One I.R.C., type BT $\frac{1}{2}$, $\frac{1}{2}$ -W., 10 megs., R5;
One I.R.C., type BT $\frac{1}{2}$, $\frac{1}{2}$ -W., 1 meg., R6;
One I.R.C., type BT $\frac{1}{2}$, $\frac{1}{2}$ -W., 0.1-meg., R7;
One I.R.C., type BT $\frac{1}{2}$, $\frac{1}{2}$ -W., 10,000 ohms, R8;
One I.R.C., type BT $\frac{1}{2}$, $\frac{1}{2}$ -W., 1,000 ohms, R9;
One I.R.C., type BW $\frac{1}{2}$, $\frac{1}{2}$ -W., 100 ohms, R10;
One I.R.C., type BW $\frac{1}{2}$, $\frac{1}{2}$ -W., 10 ohms, R11;
One I.R.C., type BT $\frac{1}{2}$, $\frac{1}{2}$ -W., 0.25-meg., R14;
One I.R.C., type BT $\frac{1}{2}$, $\frac{1}{2}$ -W., 5 megs., R15;
One I.R.C., type BT1, 1 W., 0.16-meg., R17;
One I.R.C., type BT1, 1 W., 0.73-meg., R18;
One I.R.C., type BT1, 1 W., 1,000 ohms, R19;
One I.R.C., type BT1, 1 W., 100 ohms, R20;
One I.R.C., type BT $\frac{1}{2}$, $\frac{1}{2}$ -W., 1 meg., R23;
One I.R.C., type AB, 10 W., 25,000 ohms, R24;
One I.R.C., type BT $\frac{1}{2}$, $\frac{1}{2}$ -W., 0.1-meg., R26;
One I.R.C., type BT $\frac{1}{2}$, $\frac{1}{2}$ -W., 2 megs., R27;
One I.R.C., type BT1, 1 W., 1,000 ohms, R28;
One I.R.C., type BT1, 1 W., 10,000 ohms, R29;
One I.R.C., type BT1, 1 W., 0.1-meg., R30;
One I.R.C., type AB, 10 W., 50,000 ohms, R43;
One I.R.C., type BT1, 1 W., 50,000 ohms, R44;
One I.R.C., type BT2, 2 W., 0.3-meg., R45;
One I.R.C., BT2, 2 W., 0.15-meg., R46;
One I.R.C., type BT $\frac{1}{2}$, $\frac{1}{2}$ -W., 5 meg., R47;
One I.R.C. precision, type WW4, 1,000 ohms, R13;
One I.R.C. precision, type WW4, 11.1 ohms, R21;
One I.R.C. precision, type WW4, 900 ohms, R32;
One I.R.C. precision, type WW4, 9,000 ohms, R33;
One I.R.C. precision, type WW4, 90,000 ohms, R34;
One I.R.C. precision, type WW4, 0.15-meg., R35;
One I.R.C. precision, type WW4, 0.25-meg., R36;
One I.R.C. precision, type WW4, 0.5-meg., R37;
One I.R.C. precision, type WW4, 25 ohms, R38;

(Continued on page 174)

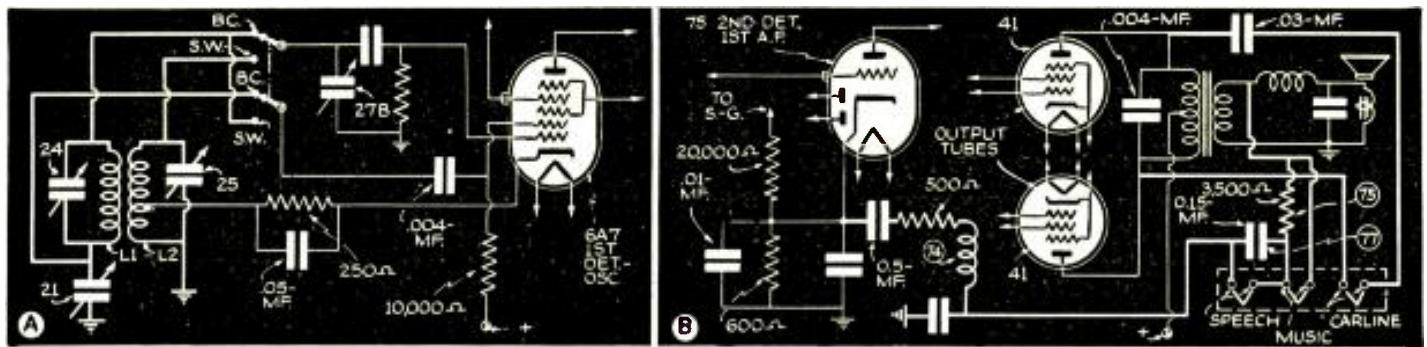

Fig. 1. New circuit features in Stewart-Warner and Philco receivers. The heavy lines accentuate the points discussed in the text.

NEW CIRCUITS IN MODERN RADIO RECEIVERS

The details of the modern radio receiver circuits that make them "different" from previous designs are illustrated and described each month by a well-known technician.

F. L. SPRAYBERRY

NUMBER 12

(1) OSCILLATOR CIRCUIT EXCHANGES PLATE AND GRID COILS FOR 2-BAND OPERATION

Stewart-Warner Models 1881 to 1889. An entirely different type of oscillator circuit is used for shortwave reception from that used in the broadcast band. Each circuit is thereby most highly adapted to the frequency band which it covers.

The circuit, Fig. 1A, shows the broadcast connection of the oscillator coils, trimmer and associated apparatus. In this position of the band-switch coil L1 is used as the grid coil and feedback is obtained by the R.F. drop across the padder (21). The section of coil L2 between cathode and ground adds very little to the oscillator for broadcast purposes. However, when the band-selector switch is thrown to the shortwave position, coil L1 is dropped out of the grid circuit and placed in the plate circuit. Coil L2 on the other band is connected into the grid circuit and its constants with the main tuning condenser and trimmer determine the frequency of oscillation. For this band, the oscillator is a cathode coupled type with the plate coil as an added insurance for oscillation.

This circuit introduces the idea of switching to optimum values to suit individual wave-range characteristics.

(2) OUTPUT FIDELITY CONTROL FOR AUTO-RADIO SET

Philco Model 928-K. One of 3 distinct band characteristics for the reproduced sound may be chosen by a pushbutton at the point of control of the receiver operation.

From observation of Fig. 1B, it will be noted that a lead is brought out from the voice coil winding of the output transformer. This lead is connected through 2 resistors, 2 condensers, and an R.F. choke back to the 1st audio cathode for the purpose of correcting the output by degeneration. The push-button switches are wired to short the large condenser (77) for speech so that the feedback will flow only through the resistor (75) of the output network. Thus, there will be about the same feedback for all frequencies. This tends to remove all of the harmonics or other distortion introduced by the circuits following the 1st-detector. It makes for high fidelity over the band usually required for speech.

For music, the resistor (75) is shorted and all of the feedback energy is conveyed through condenser (77). This makes the energy transfer rise with frequency as the reactance of the condenser decreases with increased frequency. This action tends to correct for distortion successively in the upper

frequency register.

A 3rd button shunts a fairly large condenser (48) across the output plates which practically cuts out all frequencies above 2,500 or 3,000 cycles so as to avoid carline interference.

(3) AUTOTRANSFORMER FILAMENT SUPPLY

Silvertone Model 7214. The power transformer primary is tapped for connecting the filaments of all of the tubes and the pilot lamp.

This connection as in Fig. 2A avoids the use of a series resistor, which wastes considerable electrical power. It provides a simple series filament connection without any additional turns or windings and without using large wire in the transformer. The circuit, of course, is only intended for A.C. operation.

(4) SINGLE-STAGE 25L6 TUBE REQUIRES NO BIAS BYPASS CONDENSER!

RCA Victor Model 94X. High output and high efficiency at low distortion is obtained by omitting the usual cathode bypass condenser.

The technician will realize that if an ordinary pentode single-stage circuit is connected as in Fig. 2B the signal vari-

(Continued on page 169)

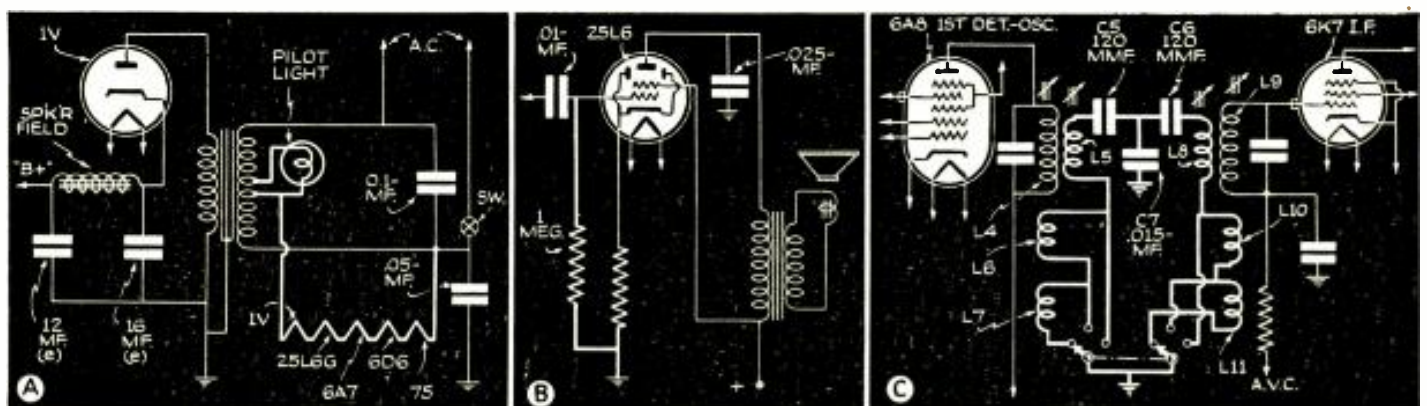

Fig. 2. RCA-Victor and Silvertone circuit details. The heavy lines accentuate the points discussed in the text.

HOW TO MAKE ELECTRONIC

This organ has been simplified to the Nth 7 keys! It's portable, and can be played vately" through headphones. A musician

M. L.

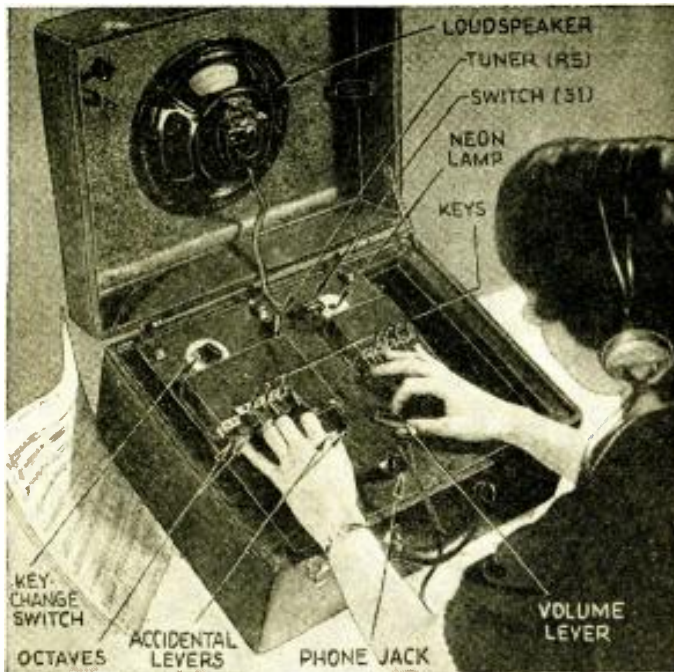

Fig. A. This simple electronic organ has 3 octaves and more notes than a saxophone.

MANKIND needlessly spends tedious hours practicing on antiquated musical contrivances while modern electronic devices can be designed to produce better results with a fraction of the ordinary operating difficulty and cost! (The writer being a musician by trade knows whereof he speaks.) This article describes a superior musical instrument effected by the electron art.

The most important details considered by a prospective purchaser are ease of operation, low cost, pleasant tone quality, and convenient shape and weight. These items are featured in the instrument described.

The ease of operation is demonstrated by Fig. 6 and Fig. A. There are two deliberate "errors" in the photograph: (1) the music manuscript should rest on the angle brackets situated on the uppermost portion of the panel. (2) More important is the fact that the operator's fingers should rest naturally on the keys. The small finger of the left hand controls the

octaves while 1 finger is allotted to each note. The thumb of the left hand is placed between the accidental levers while only the right-hand thumb controls the volume. Free use of the volume control is advisable otherwise the tone will become monotonous.

Since a trumpet or saxophone of average quality costs between \$100 and \$200, the low price of \$20 is readily appreciated by the vast number of aspiring musicians who are not able to invest so great a sum as is required.

POWER SUPPLY CIRCUIT

The power supply circuit is a conventional half-wave A.C.-D.C. rectifier system. Figure 1 illustrates the power line connections to the tubes. The neon lamp (V2), Fig. 2, will light when the instrument is ready to operate. Since the highest supply voltage is reached when the tube heaters are at operating temperature, the neon lamp may be used as an indicator because it will only light when a sufficient voltage is placed across it; resistor R1 is a limiting resistor used to protect V2. Another indication that the instrument is ready for operation is a low click heard in the loudspeaker.

AUDIO OUTPUT DESIGN

Unit T1 is an output transformer. The secondary is shunted by C1 to produce a more "pleasant" tone. Without C1 the quality of the tone contains frequencies less soothing to the human ear. The jack automatically disconnects the loudspeaker when the phone plug is inserted. This is utilized when you wish to play the instrument without interfering with the activities of other persons in the room.

OSCILLATOR CIRCUIT

The oscillator is basically the same type used to practice the radiotelegraph code. Condensers C2, C3, and C4 control the octaves available; C2 and C3 are in parallel, normally. Depressing the "HI" lever opens the circuit containing C3. This reduces the capacity thus increasing the frequency 1 octave. Depressing the "LO" lever increases the circuit capacity and the frequency is lowered one octave.

At this stage a resistor of more than 30,000 ohms should be connected from grid to cathode of V1. If the circuit does not oscillate, reverse the connections of one of the windings of T2. Then remove the resistor.

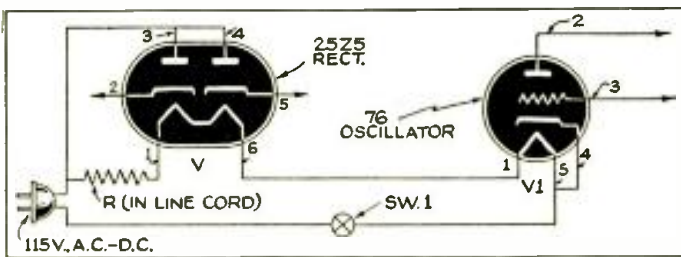

Fig. 1. The filament circuit and line cord connections.

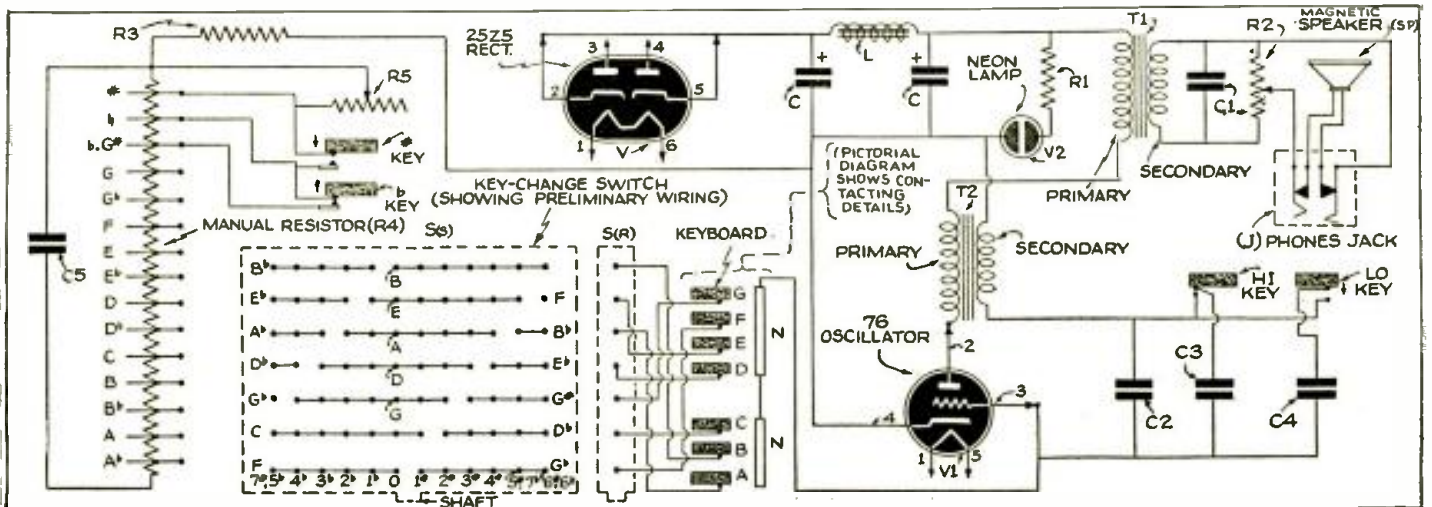

Fig. 2. Schematic of the Electronic Organ. Detailed hookup for switch S is given in Fig. 4. "Hi" key contacts, normally closed, open when key is pressed.

A 3-OCTAVE ORGAN FOR \$20

degree—has sharps and flats over 3 octaves with only either “publicly” through a loudspeaker, or “privately” through a headphones jack.

GRODER

Resistor R3 limits the low-frequency response (by limiting the minimum resistance value of R4) and hence determines the initial musical key (C concert, C International, B flat, etc.) of this instrument.

Taps on R4 supply accidentals (the sharps and flats), not noted in the key signature tuning, and individual notes. Adjustable tuner-resistor R5 is a vernier adjustment of R3 and more accurately tunes the whole range of the instrument. This is equivalent to adjusting the mouthpiece on a saxophone. Bypass condenser C5 allows all notes to be “concentrated” on R4; without C5, 4 additional R4 resistors would be necessary, and the accidental, octave and tuning circuits would have to be of other design!

KEY CHANGING CIRCUIT

Most difficult to the prospective musician is the nuisance of remembering the sharps or flats of the key signature. Sometimes 7 sharps or flats must be committed to memory!

To decrease the memory work involved, a switch, S, is incorporated in the circuit. Stator Ss is to be individually wired as shown schematically in Fig. 2 and pictorially in Fig. 3. It is then ready to be wired into the main circuit. First, refer to Fig. 4 and wire “F” on the right side of “S” to “F” on the left side of S, “B flat” on the right side to “B flat” on the left side, “E flat” on the right side to “E flat” on the left side, “D flat” on the right side to “D flat” on the left side, and “G flat” on the right side to “G flat” on the left side. After this is finished, wire the lettered terminals on the left side and

center of Ss to the corresponding tap of R4. Tap “G sharp” on the right portion of Ss is wired to tap “G sharp” on R4. The switch connections to resistor R4 are shown in Fig. 4.

The rotor of S (which is Ss) is connected to the corresponding note levers on the keyboard.

MECHANICAL DETAILS AND CONSTRUCTION

The levers are built from clothespins which of course can be obtained in the 5 and 10 cent stores. Pry the springs off with a screwdriver and you will have 2 wooden bars 3 1/4 ins. long and 1/2-in. wide. One-quarter-inch from the rear of the bar cut a notch 1/4-in. long and about 1/16-in. deep. In the center against the rear of this notch drill a 5/32-in. hole. An inch-and-a-half from

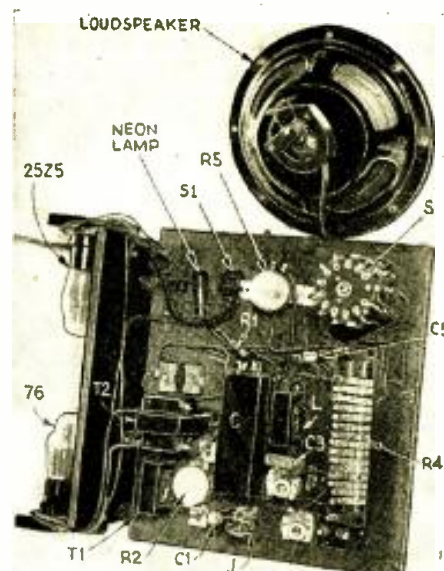

Fig. B. The chassis is made of wood with a separate compartment for the 2 tubes.

the front drill a 3/16-in. hole. One-eighth-inch from the front notch (cut by the manufacturer) two 1/16-in. holes are drilled for the contacts. Eight bars drilled in this manner constitute the “LO”, “A”, “B”, “C”, “D”, “E”, “F”, and “G” levers. See Fig. 5A.

The “HI” lever has its contact holes 1/4-in. from the rear. Two 3/16-in. holes (Continued on page 172)

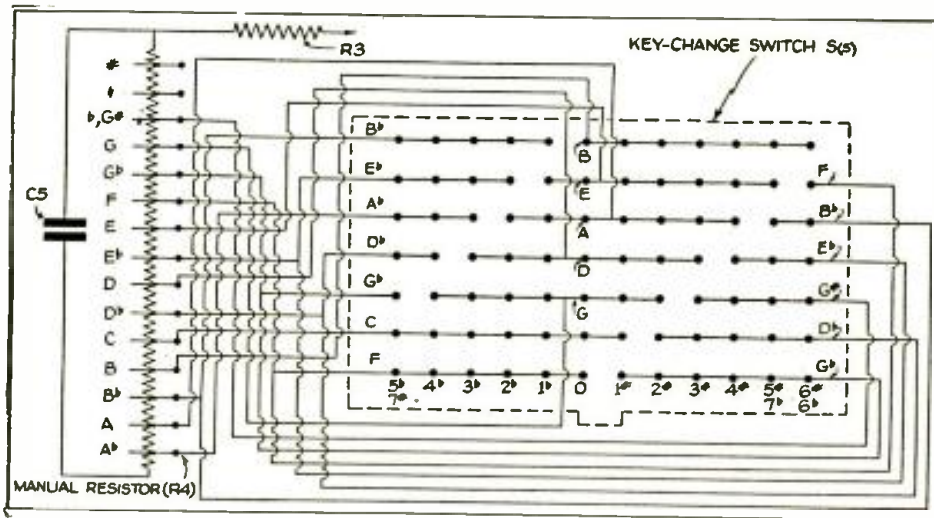

Fig. 4. Connections for the key-changing switch which automatically plays sharps and flats.

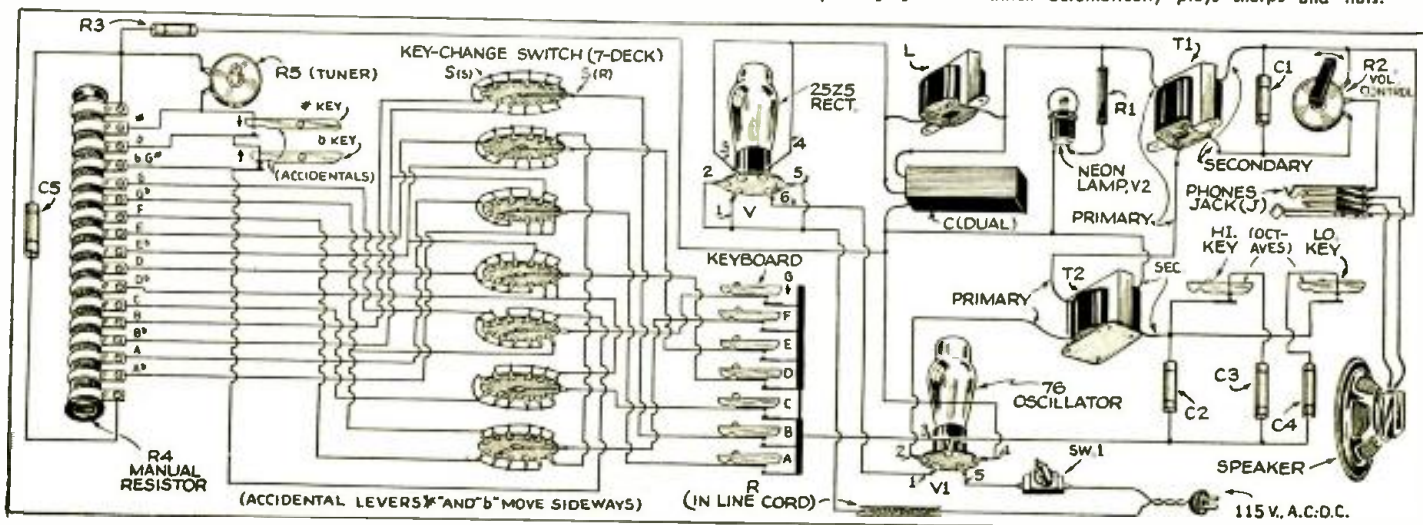

Fig. 3. Complete pictorial diagram of the electronic organ. “LO” key contacts, normally open, close when key is pressed.

Reading 'Riting 'Rithmetic ... and RADIO!



← "Lay on Macduff and damned be he who first cries half..." and thus New York high-school students bring to life once more, via radio, the immortal Shakespearean *Macbeth* and other plays. Student programs are transmitted via a local broadcast station. In the background may be seen the sound-proofed control room.



↑ View looking into the studio from the control room. Maintenance engineers are of course professional (paid by the Board of Education), but all the "acting" and most of the script writing is done by the students themselves, under the guidance of their instructors.



↑ Principal Albert L. Colston of Brooklyn Technical High School at mike of apparatus which carries his voice to his students in individual classes, groups of classes or as a whole group. The school P.A. system is also an important adjunct to fire drills and other emergency proceedings.

THERE'S a new "R" in the New York City Public Schools' curriculum—**RADIO**. There's no telling but what some day it will become more important than "Reading and 'Riting and 'Rithmetic" together!

A regular broadcast studio has been installed in Brooklyn Technical High School; programs are transmitted over station WNYC (810 kilocycles). The studio is "professional" in every way with a large control room, separated from the broadcasting floor by a sound-proof wall of double-layer glass. A complete sound-effects system is available. The school has its own emergency station which has been used successfully on two occasions. The broadcasts take place during school hours, being designed for school classes.

Programs are presented daily. Two
(Continued on page 176)

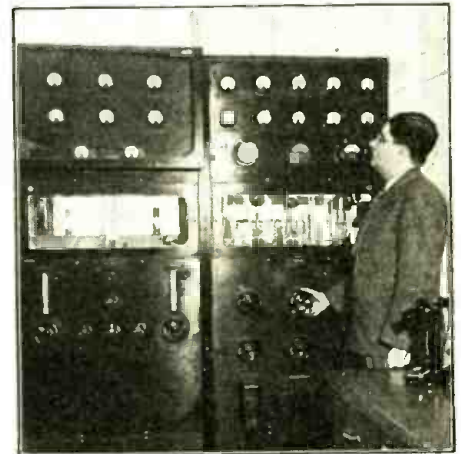

↑ Complete professional transmitting equipment is located at the Brooklyn Technical High School, where we see radio instructor Muniz checking one of the panels while the program is in progress. Students are occasionally given pointers on the operation of the equipment.

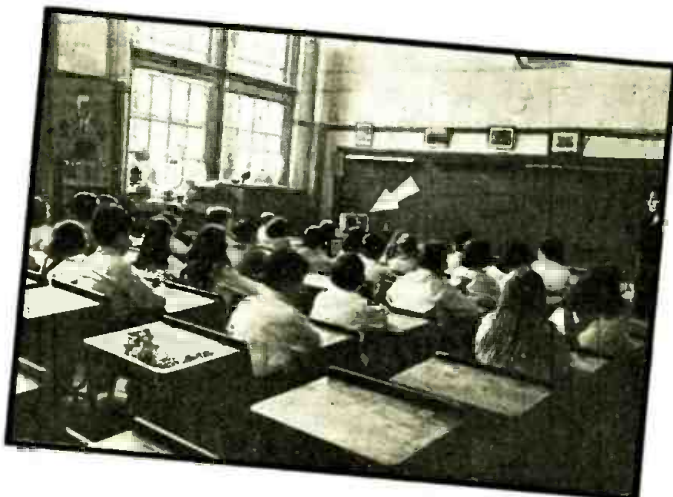

In the classrooms an ordinary radio set (arrow) is enough to pick up the school broadcasts. Here we see the 5th Grade at P.S. 92, Bronx, New York City, listening-in. Radio is being used for the first time in the New York school system to supplement the regular school curriculum.



"My fellow schoolmates..." the student announcer goes into his harangue, while the "engineers" in the background prepare to work in the sound effects when the broadcast commences. All sound effects are handled by the students. Radio is a definite aid to education.



Fig. B. Rear view. Note professional appearance, and efficient arrangement.

This new band-switching, crystal-controlled transmitter achieves in one unit the efficiency of the separate rigs commonly used.



Fig. A. Front view of the band-switch 5-, 10- and 20-meter transmitter.

40-WATT PHONE—C.W. TRANSMITTER FOR 5-, 10-, AND 20-METER BANDS OLIVER READ, W9ETI

TRANSMITTERS designed for use on the higher-frequency amateur bands have usually been limited as to flexibility in application, particularly on 5 meters. In order to retain efficiency on the 5-10-20 meter bands, separate rigs have commonly been used. The transmitter described here (and illustrated in Figs. A and B) has been designed to make it thoroughly practical to get high efficiency on those bands.

This 40-watt Phone-C.W. transmitter uses twin, class C amplifier stages together with a separate driver on 5 meters. In this way, a correct L/C ratio is obtained and no plug-in coils need be used.

A Pierce oscillator circuit using a type 6F6 metal tube provides output on the crystal frequency without the usual plate tank coil-and-condenser combination. Two 40-meter X-cut crystals must be used, as the tube circuit oscillates only at fundamental, and both 10 or 20 meter crystals are in reality a 60-meter, fundamental-cut, and will not operate in a Pierce circuit. The complete schematic circuit is shown in Fig. 2.

Complete band-switching is made possible in the circuit shown by using a special switch with parallel silver contacts to reduce the contact resistance to a very low value. Metering facilities are provided as indicated for proper tuning. Two antenna systems may be permanently connected, one for 10-20 meters (L6) and the other for 5 meters (L8).

A high-gain speech amplifier with provision for 2 inputs, and a class AB 6L6 modulator stage is contained in the center section. This amplifier-modulator has its own plate and filament supply.

The bottom chassis contains the plate and filament supply for the R.F. unit. Separate rectifiers with associated filters permit good regulation to the modulated stage.

The complete transmitter is housed in a steel cabinet measuring 21 ins. high, 15 ins. wide, and 10 ins. deep.

The oscillator always operates at 40 meters and doubling or tripling is done by the 6L6G tubes. The 2 modulated stages always are operating as a straight amplifier and never as a doubler. This feature, together with isolation from the oscillator stage affords a really clean

(Continued on page 166)

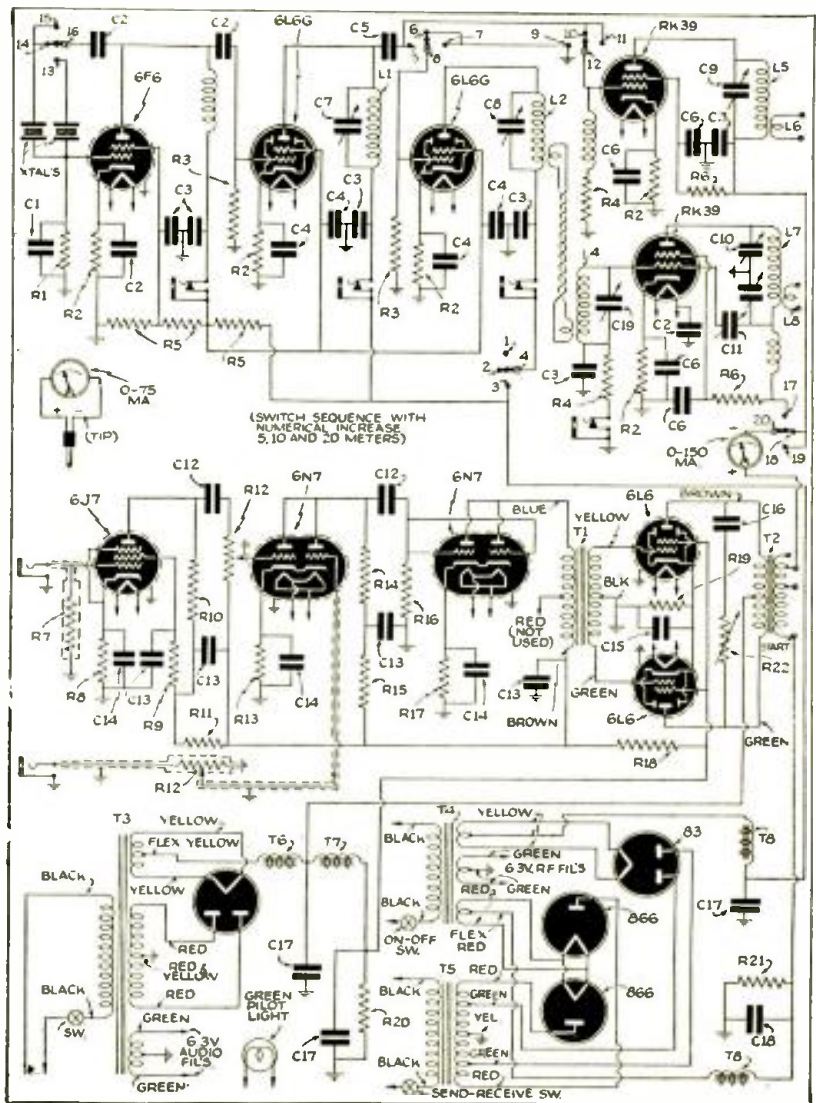

- | | | | |
|--|----------------------|--------------------------------|------------------------|
| C1—150 mmf., 600 V. | C12—0.1-mf., 400 V. | R3—20,000 ohms, 10 W. | R13—2,000 ohms, 1 W. |
| C2—0.01-mf., 1,000 V. | C13—2 mf., 450 V. | R4—10,000 ohms, 10 W. | R14—50,000 ohms, 1 W. |
| C3—0.001-mf., 1,000 V. | C14—10 mf., 25 V. | R5—25,000 ohms, 50 W. | R15—10,000 ohms, 1 W. |
| C4—0.1-mf., 600 V. | C15—10 mf., 75 V. | R6—30,000 ohms, 20 W. | R16—0.5-meg., 1 W. |
| C5—100 mmf., 1,000 V. | C16—0.02-mf., 600 V. | R7—2 megs., 1/4-W. | R17—1.500 ohms, 1 W. |
| C6—250 mmf., 1,000 V. | C17—8 mf., 450 V. | R8—3,500 ohms, 1 W. | R18—10,000 ohms, 10 W. |
| C7—150 mmf. | C18—4 mf., 600 V. | R9—1 meg., 1 W. | R19—200 ohms, 10 W. |
| C8—35 mmf. | C19—20 mmf. | R10—0.25-meg., 1 W. | R20—60,000 ohms, 50 W. |
| C9—150 mmf. | R1—50,000 ohms, 2 W. | R11—50,000 ohms, 1 W. | R21—50,000 ohms, 20 W. |
| C10—35-35 mmf. | R2—250 ohms, 10 W. | R12—0.5-meg. | R22—0.1-meg. |
| C11—cartridge-type neutralizing condenser. | | (Unmarked rectifier is a 5Z3.) | |



Dorothy Page, beautiful N.B.C. singer and motion-picture star, being telecasted. In the foreground are the shadowy outlines of floodlights and the Iconoscope television camera. The microphone is suspended from a swinging boom, over Dorothy and out of camera range.

Backstage of the N.B.C. television studio actors Grace and Eddie Albert make-up for the Iconoscope camera. Complete facial make-up essentials, viz., grease paint, mascara, powder and lip rouge, are kept on hand. Engineers are striving to eventually do away with make-up.

One of the experimental television receivers installed in the homes of a group of engineers. The receiver, about as experimental as the present-day transmitter, is about the size of an average console radio. Will future television receivers have as many controls as this one?

WHEN TELEVISION

It is the opinion of the author, in the light of his experiences as a much more upon movie technique than upon radio technique for

C. A.

ON the tip of many tongues today we find the word TELEVISION backed by an eagerness to discuss the subject. That yen for discussion far surpasses the ken of the aspirant. Most of such palaver revolves around the development and operation of the apparatus which will unleash this new giant from its laboratories.

Let us instead digress and consider the production values and program treatments possible through this new medium. Let us discuss and compare the relations between this young brat and today's Talkies or Sound Pictures.

TELEVISION RELATED TO SOUND MOVIES

When sound came in for movies on a large scale in 1928 the greatest studios with all their wealth and talent were at once reduced to a panicky state of helplessness. A giant in ramification this demon "Sound" was destined to revolutionize their entire industry. Yet what happened? In less than a year all acceptable grade A productions were turned out with apparatus somewhat as crude as were the new performance technique and methods of handling.

The reason for emphasis here is to remind the reader that if television bugaboos of the future with their attending financial worries seem insurmountable, he need but reflect appreciatively upon the glamorous, super-productions billed on every marquee today. Whatever productions you wish, are served out to you from one tiny, innocent sound track or record which is merely a strip of recorded light variations 1/10th of 1 inch wide along the edge of the standard 35-millimeter movie film.

Now how was all this accomplished so quickly and easily? How was that brat rushed into long trousers with but a trace of awkwardness while he wore them? We find that the major West-coast studios, though well equipped financially, dared not attempt to build their own sound equipment for they knew well that their investments must be placed in apparatus which could constantly be added to or modified to keep it abreast of changes as the new Talkie medium progressed. They therefore contracted with such firms as the American Telephone & Telegraph Co., and the Radio Corp. of America. Necessary standards were set up for the protection of not only the producers but also the theatre owners who in a like manner could not afford to have their equipment become obsolete.

Those same two are already the majors in the manufacture of television equipment.

STANDARDS

Very comforting indeed is the thought then that monies invested in television equipment will not prove within the 12-month to have been spent for junk. *If standards be set up and agreed upon* between such organizations as the F.C.C., the R.M.A. and the recognized builders of the pending equipment it is reasonable to assume that it will serve for some years. International accord has already adopted the 441-line transmission.

Some scribes claim that the smaller independent will reap the greater harvest when the magic boxes become available. Well, no one knows the answer to that one. They certainly will cut their

inroads into the harvest. Still, we already have the coaxial cables and *if* they be a vital factor, better ones can be developed. This writer fails to see how the little fellow, or even more haughty independent, can afford more than a very limited coverage during the next few years.

The camera and lighting problems already parallel themselves basically with the movies. When color first became prominent in pictures it was necessary to burn up the actors with gangs of arc lights. Rapid strides since have made it possible to reduce the ferocity of illumination. Today, television-camera sensitivity *surpasses* film-camera sensitivity! This bears along with it not only comfort for the actors but economy in electric bills.

UNIVERSAL LANGUAGE OF PICTURES

Advertisers know the value of the

The actual lady



Betty Goodwin, N.B.C. television announcer, as she appeared before the Iconoscope television camera in a Radio City studio

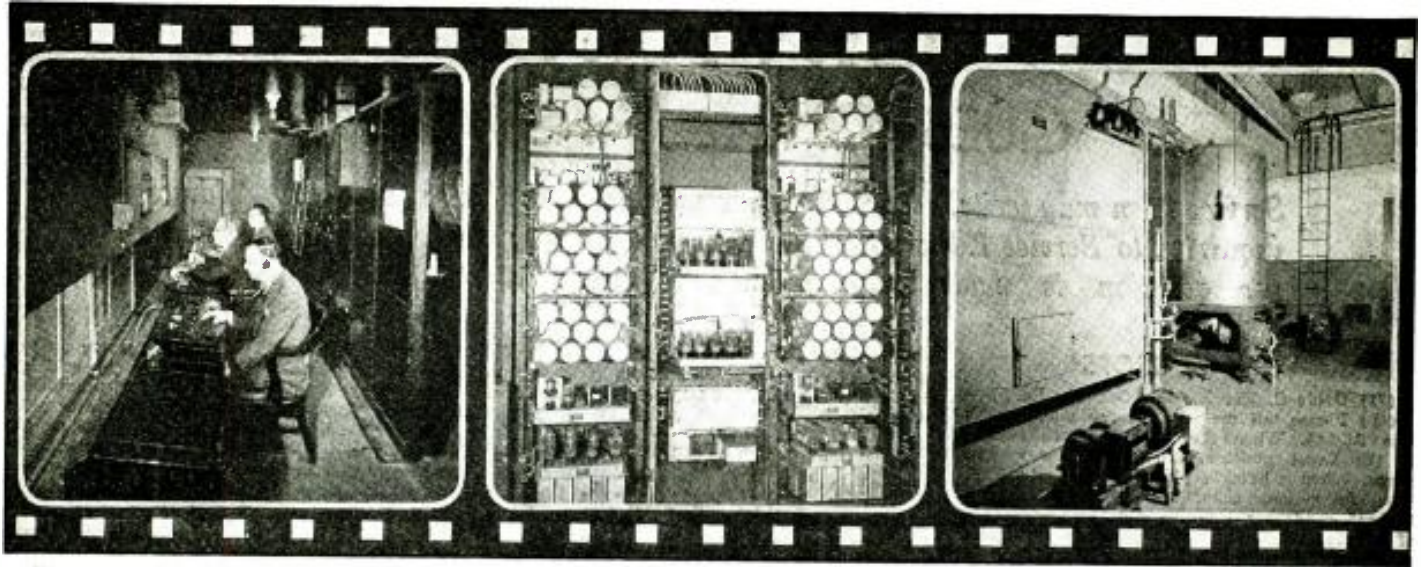

The nerve center of the television transmission! Here (nearest you) is the audio engineer who monitors the voice part of the program, then the program director, and next to him, the video or picture engineer who controls the size and brilliance of the television image.

The gadgets that make the watch tick! Back view of the synchronizing signal generator panel of the N.B.C. transmitting equipment. This particular apparatus is the heart of the system, responsible for the proper formation of the image on the screen of the receiver.

Water, water, everywhere . . . in steel tanks. The water is used to cool certain high-power transmitter tubes. The round tank (rear-right) is a storage unit while the larger one (left-foreground) actually does the cooling. This is only one of the many rooms comprising a television station.

COMES AROUND!

Hollywood sound specialist, that commercial television will rely staging video shows. His article emphasizes this viewpoint.

TUTHILL

universal language of pictures. Pictures everywhere, better yet in your own home, arrest a commanding attention. When they take on the further realism of life or action possible through radio movies, their appeal and sales force will become far more powerful than any running, vocal, unseen commentary. You can read a book while you listen to "the radio" but you cannot while you look at it. A powerful talking point!

Imagine some favorite radio or screen celebrity modeling the latest styles from Paris. Most any lady of the land would gladly drop her work to witness a fashion preview. Similar presentations could be daytime projections when facilities are available at lower cost.

Our education since crude radio days before the networks were born, and since the nickelodeon days of the cinema, has equipped us to better cope with a new technique when we apply television. The psychology of a gullible

. . . . **The televised lady!**



. . . And here is Betty's 441-line unretouched image as it appeared on the screen of an experimental receiver—a far cry from the old 60-line images.

public will aid progressive development, when first movies are ethered to the home. Fortunately we become immediately engrossed in anything new. While technicians strive feverishly for improvement during the early days, people will grab zealously the first offerings unmindful of general crudeness.

AVERAGE AUDIENCE

The powers behind motion pictures have been convinced for years, that it is the "dimes and nickels" which support their industry. Ultra-sophistication in pictures is practically disastrous. Unimpeachable conclusions of exhaustive research, though far from being complimentary, have declared the average nationwide mentality of movie-goers that of a youngster. However, the ante, or perhaps better, the "intelligence quotient" of the television audience may be less shocking. During its teething months the new babe will only disport itself in homes where there is money enough to afford its costly diapers and where we hope there is an attendant measure of education befitting such environs.

Women will become so thrilled with the realization that they, in their own homes, are seeing their heart-throbs, yeah their Vallees, Ameches, Tibbetts and whom not, that they will not at first care much if they perform before cotton back-drops. Men will only be semi-conscious of the blurred framings surrounding their Hildegardes, La-mours, and other "glamourenes." Animated cartoons could inexpensively, yet effectively, be projected by sponsors of children's hours. Popular comedians fortified with good material augmented

by well-chosen musical support, can always hold a composite audience. Expensive settings would mean nothing to them. The meat of their material is their dialogue and their facial expressions which could be put over in close-ups.

Hundreds of thousands of feet of movie-film are shot to make possible the distribution of 7 or 8,000 feet, the normal feature release today. Some of the balance is filed in vaults and the rest is thrown away. Similarly this applies to that good material eliminated from the average 900-foot newsreel merely for lack of room to include it. Such negatives, shipped in from all parts of the world, need be but quickly printed in a lab. to be available for television at a very reasonable figure. Can you imagine how some agencies will pounce upon that?

RADIO STUDIOS VS. HOLLYWOOD STAGES

Sketchy transmissions might be enlarged upon by setting-up a second camera farther back from the talent to include quite a spread of musical or pictorial support. In even the larger radio studios, however, there is a very limited amount of space for extensive set construction. That fact carries along with it the definite lack of facility for employing more than a scant few sets for any one production. This seems to set up as futile any attempt on the part of the radio studio to rival the glamour and variety of a Hollywood super.

For example, suppose in the boiling down of a 1-hour script, for reasons of avoiding prohibitive costs, provision is made to cut back and forth frequently

(Continued on page 168)

SERVICING QUESTIONS & ANSWERS

Service Men may write, requesting answers to specific service questions. Address inquiries to Service Editor. For questions answered by mail, a service fee of 25c per question is made. Only questions of wide interest can be published.

VOLUME DROPS

(71) Ovide C. Harris, New Orleans, La.

(Q.) Please tell me what is the matter with this RCA46. When the Local-Distance switch, in the Local position, is touched the volume drops. When a hand is placed near the 1st R.F. tube the volume rises. Would you consider a 1.25-mf. condenser defective if it has a resistance of 1 meg.? This set works perfectly for hours at times, but eventually it starts to sputter and fade away. All sections of this same set went "west" at the same time. What could have caused it? I noticed, too, the power transformer heats a little after about 2 hours' operation.

(A.) The effects you note with regard to touching the Local-Distance switch in Local position and placing a hand near the 1st R.F. tube are both normal for this receiver. In the Local position of the switch, the antenna proper is not employed.

The question regarding "goodness" of a 1.25-mf. condenser with 1 meg. leakage cannot be answered unless the use to which the condenser is put is known. Ordinarily, leakage of this low order renders a paper condenser useless for any purpose. Most likely, this is the trouble with your receiver. Replacement of the 1.25-mf. condenser is recommended.

WHISTLE ON ALL STATIONS

(72) Byron F. LaDue, Rochester, N. Y.

(Q.) I had a Philco model 111 in for repair recently. The complaint was a whistle on all stations, starting up after the set was playing 15 minutes or a ½-hr. and continuing until turned off for an hour or so. I brought this set into the shop and substituted all tubes, checked all condensers for intermittent opens on an R.F. breakdown tester and returned the set to the customer.

I was called back next day and returned the set to the shop. This time the whistle was in the set when I turned it on, but on shunting a condenser across one of the bypass condensers to check for open, the whistle stopped immediately and the set played OK, defying all efforts to cause the trouble to return, by letting the set cool or by playing it for hours.

After 2 days of this, without the trouble returning, I realigned the set again and returned it, saying I couldn't do any more, if the trouble returned. As I expected, the trouble returned in a day or two.

(A.) The complaint of an intermittent whistle or oscillation experienced with the Philco model 111 receiver has been traced in most cases to open-circuiting 0.05-mf. grid filter condensers in the R.F. and I.F. stages, as well as a 0.05-mf. plate filter condenser in the first A.F. stage. The open-circuit consists of a break of the connecting lead at the lug or within the case of the bakelite-cased condensers. These units are numbered 6, 67, 28 and 45 in the Philco schematic for this receiver.

BROAD TUNING, FREQUENCY DRIFT

(73) Frank Ross, Faribault, Minn.

(Q.) We have a Sky Buddy model 5T which has a very bad case of broad tuning with frequency shifting. The tone is very good and we have tested all condensers and resistors.

(A.) Broad tuning in the model mentioned in your letter is due to misalignment, as well as the fact that only a 2-gang condenser is employed. We suggest complete realignment and the use of a shorter aerial. Frequency drift is due to poor

trimmers. Which trimmer is at fault may be determined after alignment. In the event of further drift, ascertain the trimmer which requires readjustment.

SUSTAINED AUDIO NOTE, NON-CALIBRATION, TUNABLE HUM

(74) Rudolph Wheaton, Jacksonville, Fla.

(Q.) I have an Atwater Kent model 84 (early) in for repair that has a sustained audio note when dial is set from 1,400 kc. to 1,500 kc. and volume on full. No stations are received between these 2 points. According to voltage tables of manufacturer, voltages are OK except bias. Resistors and condensers are OK. This set is 10 kc. off calibration and cannot be aligned. Also there is an annoying tunable hum on strong signals.

(A.) The symptoms mentioned in your letter, concerning oscillation at the high-frequency end of the broadcast band and modulation hum, on an Atwater Kent model 84 receiver, point to carbon resistors which have altered in value. The most common offenders are the type 24A 2nd-detector screen-grid and cathode resistors, 0.1-meg. and 20,000 ohms, respectively. The oscillator grid leak, a 40,000-ohm carbon unit, usually causes trouble in this receiver. We suggest that all 3 resistors be changed.

PLEASE LET US KNOW . . .

. . . whether the problems published in this department are your problems; whether they help you in your daily service work; whether they are instructive in character, thus helping you to better understand radio. Servicemen, this is your department, so please let us have your ideas and opinions. Address all letters to the Service Editor.

Check the 2nd-detector, screen-grid and cathode bypass condensers by shunting additional capacities across the present units during operation.

NO SIGNALS

(75) A. J. Simon, Indianapolis, Ind.

(Q.) I have a Majestic model 70 for repair and am unable to receive any signals unless I remove the 2nd R.F. tube shield and place my hand over the tube, or by removing the tuning condenser gang shield. The signal increases in strength as the condenser shield goes back in place and stops when it touches the chassis. All voltages seem to be normal and I think the trouble lies in the antenna coil or the R.F. coils, both of which I have checked and find OK.

(A.) From the symptoms described in your letter, it would seem that the trouble experienced with the Majestic model 70 receiver is due to either one or more of the following:

Since signals are received with the 2nd R.F. 26 tube shield removed, the cause for inoperation definitely lies ahead of this stage. Check the 1st and 2nd sections of the gang condenser for a short-circuited or grounded condition by removing the white leads to the stator plates, and employing some continuity test. The trimmer across the 2nd section of the gang or the neutralizing condenser between the 1st and 2nd R.F. stages may be short-circuited. Test latter condenser with leads disconnected.

Inasmuch as you state the antenna and R.F. coils have been checked as satisfactory and voltages are normal, these are the only possible causes for your difficulty.

MOTOR-GENERATOR WHISTLE

(76) M. F. Crowell, Jr., Crowell, Tex.

(Q.) Can you give me any help on the follow-

ing service problem? A local theatre owner brought in a portable 6-V. amplifier sold by Montgomery Ward & Co., with a complaint of too much noise from the motor-generator that furnishes the high-voltage supply. In this amplifier a 37 feeds into a 6A6 which is resistance-coupled to two 42 tubes.

Checking the plate and high-voltage leads with my oscilloscope, they seemed to be well filtered. (The noise of the motor-generator sounded something like a high-pitched fire siren and had a very annoying ratio to the output signal.) By hooking the vertical plates of my oscilloscope to the "hot" battery cable I found what appeared to me to be the high-pitched noise. I then tried shielding all the cables and all leads into the motor-generator but only made the noise worse. After removing the shield on the 2 battery cables I (by accident) found that I could eliminate the troublesome whistle by holding the cable of the "hot" side of the battery in a certain position. In any other position other than that one the noise would increase. Shielding the "hot" cable from the battery made matters worse. Can you give me any help as to how I can stop the noise completely?

(A.) Since no schematic diagram of the portable amplifier mentioned in your letter is available, it is possible only to discuss your difficulty in generalities. From your description of the trouble, it would seem that the annoying, so-called whistle is due to faulty, insufficient, or lack of R.F. filtering in the power supply. To correct a condition such as this, an ordinary auto-radio "A" choke is usually connected into the "A" hot lead to the amplifier, bypassed with 0.5-mf. condensers, connected before and after the choke to chassis. To complete the filtering, insert a 2.5 mhy. R.F. choke into both the "B+" and "B-" leads of the motor-generator output, each choke bypassed to chassis through a 0.5-mf. condenser. Shield the types 37 and 6A6 tubes.

EXCESSIVE BACKGROUND NOISE

(77) Basil W. Anger, Fort Erie N., Ont., Canada.

(Q.) I have been servicing radio sets for the past 4 years and have encountered the first difficulty for which I have had to call for help.

It is with a Stromberg-Carlson model 240M bought new, November 6, 1937. This set has a terrible rushing, frying sound over the entire tuning range. Also it does not pick up as many stations as it should. The only stations you can listen to are locals, which, when tuned in, reduce the intensity of this rushing, frying noise to about half.

(A.) Your description of trouble with a Stromberg-Carlson model 240M points to either insufficient antenna pick-up or a defective R.F. stage.

Check the antenna system employed with the receiver, closely, for breaks or lack of continuity. Adjust the "signal admission" switch located at the rear of the chassis. This control has a slotted shaft which protrudes through the rear base of the chassis.

Check the antenna coil primary for an open-circuited condition. Should this prove intact, then test the 0.04-mf. grid filter condensers in the R.F. and I.F. secondary-return circuits for an open-circuited condition.

INTERMITTENT OPERATION

(78) Al Dubatowka, Norwich, Conn.

(Q.) I am experiencing difficulty with an Atwater Kent model 275 A.C.-D.C. receiver. All

(Continued on page 176)

OPERATING NOTES

ANALYSES of RADIO RECEIVER SYMPTOMS

SERVICE MEN—What faults have you encountered in late-model radio sets? Note that RADIO-CRAFT will consider your Operating Notes provided they relate to characteristic (repeatedly encountered) faults of a given set model. Payment is made after publication of the Operating Note.

Trouble in . . .

. . . SENTINEL 73B, 1937 LATE SERIES

*Audio Trouble—Squeak and Howling:—*All these models develop audio trouble causing howling and squealing due to volume control and associated circuit. Clean the 0.5-meg. volume control with energine; also shield grid lead from 75 to grid-bias cell. Also install a 0.002-mf. condenser from left side of volume control to ground. This I think will add a more pleasing tone to the receiver.

. . . PHILCO 38 & 38A

*Cutting out, and losing volume, or not osc. at all:—*These sets give very much trouble on the coastal regions and also in this part of the country (Texas). Due to moisture affecting these sets they only pull in a few stations around 1,200 to 1,500 kc. or sometimes don't work at all. The proper procedure in working over these trouble-makers is to take out all coils—R.F., Osc., and both I.F.—and boil them in paraffine and beeswax for about 10 minutes. The final dipping, so as to give the coils a hard wax covering, is made in a formula of one half pound paraffine and one quarter pound beeswax which can be had at any drugstore.

The next step is to clean the wipers on the gang condenser, by taking them off and soldering them back in place for a better contact, and for a better ground it is better to use a piece of heavy braid from condenser gang to ground. The third step is to change the oscillator condenser which is 150 mmf.; even if it does check OK, change it anyhow. The 6,000-ohm resistor across the condenser colored blue seldom gives trouble. Rebalance and align the receiver and, presto, it will work like a new one. Your customer will be very much pleased, that he doesn't have to keep coming back for a thawing out (hi!). The I.F. is 470 kc. The fourth step should be to take the volume control apart and clean it in energine. This is an efficient means of correcting a noisy volume control.

KENNETH BABB

. . . T.R.F. A.C.-D.C. MIDGET SETS

*Circuit oscillates and squeals with volume control set near maximum setting:—*To eliminate oscillation completely break the connection from detector coil to plate prong of R.F. tube and install resistor in series. Resistor should be around 10,000 ohms. Best value can be determined through experiment.

If the set has no screen-grid dropping resistor, it is advisable to install one (about 0.1-meg.) along with a bypass condenser.

In my experience, 99 out of 100 of these midget sets "squeal" or oscillate when too much volume is turned on. This resistor method eliminates this condition entirely without appreciable loss of signal strength.

W. E. DULIN

. . . PHILCO 3 TRANSITONE AUTO SET

No reception. Check first for broken leads to the A.F. transformer and to the volume control inside the control cable as these seem to break most often. When the set has been repaired, and there is still no reception, examine the speaker socket for enlarged holes which allow the plug to be inserted the wrong way. These tips may save you a surprising amount of time.

. . . KING MODEL 2018

(By Williams Piano Co., Oshawa)

These old Canadian orphans give little trouble other than distortion, hum and mussy reception which gradually develops in all cases from open filter condenser sections. Locate the defective sections by bridging with an 8-mf. dry electrolytic, or better, by regular condenser test. Leave the old block as it is and use single or dual 8-mf. electrolytic units of the new compact type, placing them in convenient spaces underneath the chassis. Increased filter capacity improves these sets wonderfully.

. . . PHILCO MODEL A-91

Noise and cutting off of signals when the dial is turned seems a simple trouble to locate, but actually it may be some time before you discover that the innocent-looking gang condenser stator lug grounds on the frame microscopically when you turn the tuning knob. Bend it away.

. . . MAJESTIC 90

Fading and hum can often be cured and reception improved as follows: Remove power pack from its receptacle. Disconnect green lead from the 3rd lug from the top of the filter block and leave it connected to the 2nd lug (to which it is already attached). Connect the positive terminal of one small 8 mf., 600-V., dry electrolytic condenser to the terminal on the fibre terminal-strip to which the green lead connects, and the positive lead of a similar unit to the 4th lug from the top of the block. Ground both negatives to chassis. Also, hum is often reduced materially by matching the push-pull tubes correctly.

GEO. ROGAL,
Ontario, Canada

. . . RCA VICTOR 140, 141, 240 & AVR-1

Intermittent reception on these models appears to be the chief cause for complaint and has been traced to a number of failures. The most frequent failure lies with the waveband switch, the contacts of which lose tension or become corroded, and produce not only an amazing condition wherein reception is cut off completely or reduced to a lower volume level on any one or all of the 4 tuning bands, especially the broadcast band, but also a rasping or scraping noise with the switch set on the desired band. Insufficient tension of the contacts may be checked by close observation, that

is, by watching the contacts move up and down on each section of the switch as the rotating member passes under it. Contact blades that do not meet the requirements of this test may be bent downward toward the moving contact, when they are disengaged however, to increase their tension or pressure upon the moving contact when the latter comes up under each. After this procedure, the stationary and moving contacts of the waveband switch should be thoroughly cleaned with carbon tetrachloride or similar preparation with the aid of a small, stiff-bristled brush.

The same condition of intermittent reception is caused by open-circuiting coils in the R.F. or tuner assembly. The open-circuit consists of coil leads snapping at the lug terminals and will result in total inoperation for that band in which the coil is located. Since the short-wave coils are wound with heavy-gauge wire, trouble on this score is almost always experienced with the A and B bands. By removing the shield assembly, all coils and terminals are exposed. A prodding instrument which will not cause further damage is effectively employed at this point to determine snapped leads where a visual examination does not disclose the break. To determine whether the intermittent condition is occasioned by open-circuiting coils, use a continuity meter or ohmmeter from point to point after switching off the receiver, observing the precaution of not disturbing the chassis when testing, or the trouble may clear before it is found.

Fading or intermittent reception is also due to short-circuiting trimmer condensers and leads within the 1st I.F. transformer. When trouble is present as a result of this failure, reception cuts off with a good deal of popping. This latter symptom may be reproduced by tapping the unit itself with the back of a screwdriver or other suitable instrument. In some cases, it may be necessary to renew the mica insulating spacer on one or both trimmer condensers. Shorting coil leads are easily cleared.

The symptoms of a low-pitched hum and weak, distorted reproduction have been traced on a number of occasions to an open-circuited section of the push-pull output transformer primary. This assembly is mounted on the frame of the reproducer. Since a single type 53 tube is employed in the push-pull output stage of these receivers, the usual practice pursued by many Servicemen, of removing each output tube in turn to determine operating conditions will not suffice here. A quick check may be made with an ohmmeter between either rectifier filament terminal and each plate terminal of the 53 tube.

. . . RCA VICTOR 143, 242, 341

The complaint of very weak response on these models, where the signal is barely audible, regardless of the position of the
(Continued on page 189)

THE "HIGH SEAS 4"

The tang of salt air and the roll of the sea, and the have been captured in this nautical lamp; which the seeming realism of these yesterdays that radio

N. H.

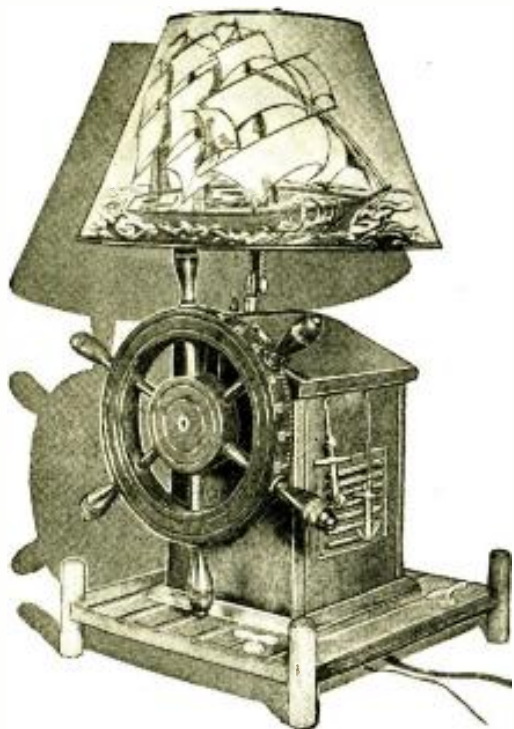

Fig. A. The completed "High Seas 4." Spinning the helm tunes the set. Pulling the right anchor increases the volume; the left, decreases. The long pull-chain (its tip is painted red) turns on both the 40-W. series lamp and the set; the shorter chain, the independent 60-W. lamp.

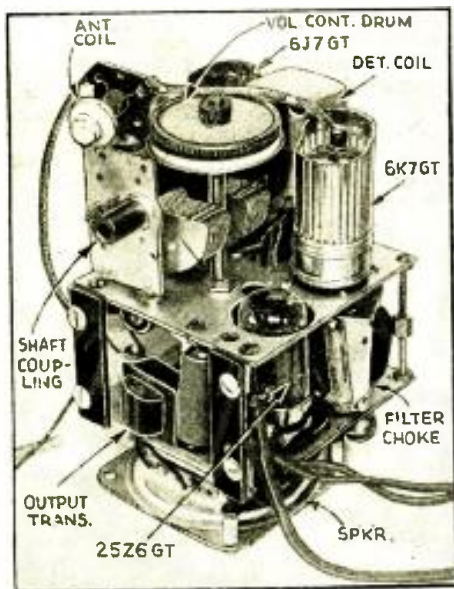

Fig. 8. Front view of the compact 2-deck chassis. Two of the tubes are mounted on the top deck; the other 2 (one does not show here), on the lower deck—but protruding through the upper. Placement of parts is not very neat since all the parts, with space at a premium, had to be crammed in wherever they fitted.

EVERY once in a while (too often, says the missus) your author gets an urge to build a novel radio set of some kind. A preceding one, the "Alarm-Clock Wall Radio" (November, 1937, *Radio-Craft*) met with considerable favor. The one preceding that, the "Lazyman-4" (October, 1935, *Radio-Craft*) was to his knowledge, the forerunner of the modern pushbutton-tuning receivers; latch-type pushbutton switches not being available at the time, ordinary double-pole, single throw toggle switches were employed to "tune in" 6 favorite stations. These two receivers are mentioned merely to point out that, though novel, they were extremely practical. And so it is with this Lamp-Radio Set.

FEATURES OF THE SET

This set serves the dual purpose of *reading lamp* and *radio receiver*. Except for the antenna wire, there is no outward indication that the lamp contains a hidden "radio." (The author is now informed that there is on the market a line cord consisting of 3 conductors for the express purpose of hiding the antenna wire. It is made especially for wall-type receivers, so that there will not be too many wires showing.)

Pulling the chain on the socket of the 40-watt lamp also turns on the set. Although the 40-watt lamp does not light to full brilliance there is sufficient light for comfortable reading. The power which is ordinarily wasted in the line-cord resistors or ballast tube of the typical A.C.-D.C. receiver is here utilized in lighting the lamp. That's why the lamp switch also turns on the set. The lamp is wired in series with the filaments of the tubes. It could be made to light to full brilliance by shunting

resistors of the proper size across the tube filaments, but that would mean 4 additional resistors to be added to a chassis which, due to limited space and compactness, is already crowded. If you build the set to slightly larger proportions you can incorporate these units. You may even use a 60-watt lamp then, provided the resistors are of the proper value and power rating.

The author will gladly help you figure out the values of these resistors if you will give him the value of your line voltage and the size lamp you intend to use.

The best arrangement, however, is to use 2 pull-chain sockets and 2 lamps—one, a 40-watter for the filament circuit and the other, a 60-watter (independent of the set) to give more light when desired—as shown in Fig. 3. Figure 1 shows the connections for both lamps. Since 2 chains will be hanging from the lamp, the tip of the one which turns on the set should be painted red. NEVER use a larger bulb in the 40-watt lamp socket.

On the right side of the lamp are 2 ornamental bronze anchors suspended from ropes. Pulling the right anchor increases the volume while pulling the left one decreases it. Figures E and 3 show how this is accomplished.

A STANDARD, VERY SIMPLE CIRCUIT

With the exception of a few changes in the filament and filter circuits the Lamp-Radio Set uses the circuit of a small commercial receiver. It is therefore fool-proof and cannot fail to work properly if the schematic and pictorial diagrams (Figs. 1 and 2) are carefully followed. The construction of a set of such small dimensions is made possible only by the use of the new small-size tubes put out by Arcturus.

They afford a considerable saving in space, but even at that, in order to make use of every bit of space the chassis

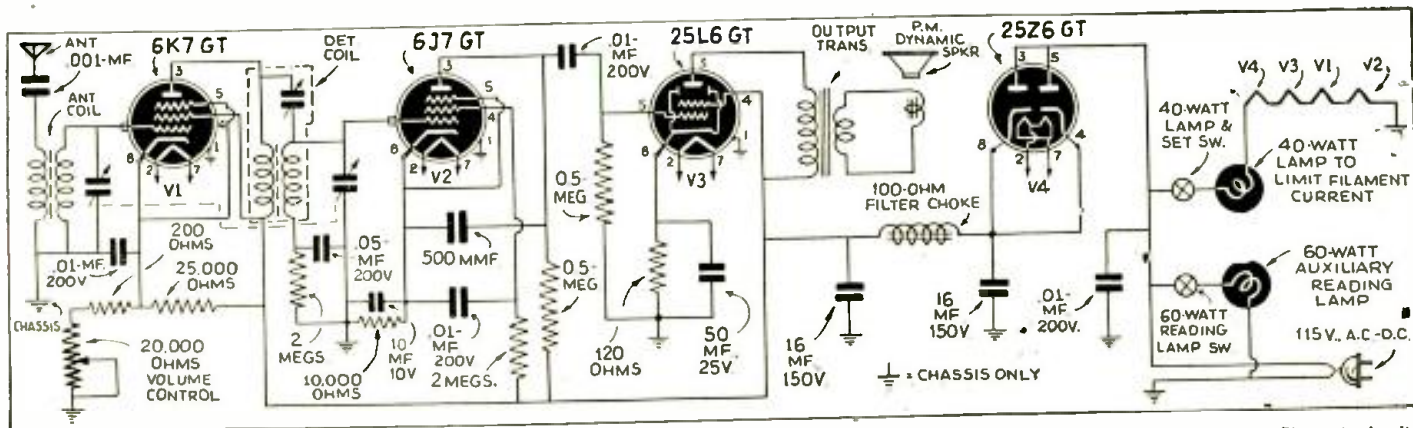

Fig. 1. Schematic diagram of the "High Seas 4." The 60-W. lamp is independent of the set whereas the 40-W. lamp is in series with the filament circuit.

UTILITY LAMP-RADIO

romance of days and nights on the bounding main, also brings to you, via its concealed radio chassis, sea stories convey. There's novelty and utility here!

LESSEM

had to be constructed in the form of 2 decks. Since all the components are so crammed, it would be difficult to show their positions by photographs alone, hence the sketch of Fig. 3.

Iron-core R.F. and detector coils are used to obtain maximum efficiency from the receiver. The 4 tubes used are: a 6K7GT, as R.F. amplifier, a 6J7GT as detector, a 25L6GT as power output tube and a 25Z6GT as full-wave rectifier; the "T" in the type number designates the new small-space line. The filter circuit consists of a 100-ohm A.F. choke and two 16-mf. electrolytic condensers of the new ultra-small type.

The filament circuit is standard except that no pilot light is included. It is not needed since the reading lamp indicates when the set is operating, and illuminates the dial marks on the periphery of the helm. Notice that the line switch is in the filament circuit only. When the set is turned off, the plate of the rectifier tube remains connected to the line, and since the cathode cools slowly, the set will continue to play for about a half-minute, gradually fading into silence.

CAUTION: The chassis is part of the line circuit and is always connected to it, whether the set is on or off; therefore NEVER touch a ground wire or any grounded object (including yourself) to the chassis. Further, the lamp socket and stem must be neutral, that is, must not touch the chassis or any open wire or form part of any circuit.

PLACEMENT OF PARTS

As shown photographically in Figs. B, C and D, and diagrammatically in Fig. 3, the 2 decks are spaced about 2 1/4 ins. apart and held together by means of bakelite strips in front and bolts in the rear. The 2-gang tuning condenser, antenna and R.F. coils, and tubes 6J7GT and 6K7GT, are mounted on the top deck while the 2 remaining

tubes together with the filter choke and output transformer are mounted on the lower deck. The 3-in. permanent-magnet dynamic speaker is inserted 2/3 of its length through the large hole in the bottom of the lower deck with its cone facing down. Inasmuch as the lamp is set on 4 legs (see Fig. A), there is ample room for the sound to come from the underside. This of course is not the best acoustical position for the speaker but will have to serve for our purpose. The volume control is mounted on the underside of the top deck and in such manner as to have its shaft vertical and also pass between the 2 rotor sections of the tuning condensers as they swing open and shut. As shown in Fig. E, a drum, made by soldering the cap of a jelly jar to a 1/4-in. shaft coupling, is fastened to the top of the shaft in order to permit operation of the control with cords (as explained in earlier paragraphs).

WIRING TIPS

Wire up the filament circuit first, being sure to wire up the tubes in the sequence shown in the diagrams. The filament of the detector tube should be the last one wired. Remove the speaker while wiring. That will save it from possible injury and at the same time will afford more room in which to work. A soldering iron with a thin, long tip will make wiring lots easier. Three or 4 tie-in strips will also help. The 6th prong of all sockets (looking at the bottom side) are "dead" and hence may be used as convenient tie-in lugs.

Check the filament circuit before proceeding. With all tubes in place and the 40-watt bulb in its lamp socket, plug the line cord into the outlet and pull the chain switch. The Lamp should light up to about 3/4 of its brilliance.

If everything is all right, wire up the power supply next and bring the "B+" (Continued on page 175)

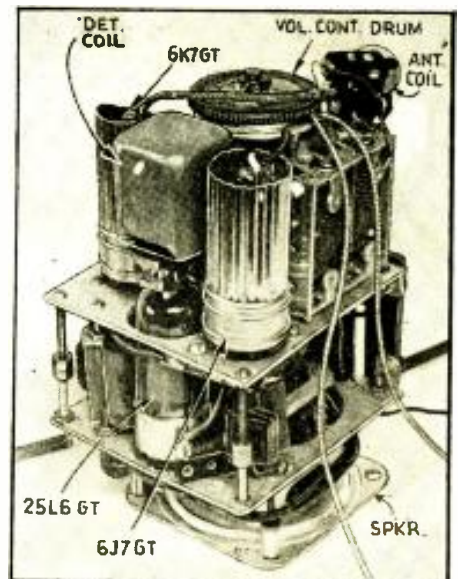

Fig. C. In this view we see that the output tube (not seen in Fig. B) is located on the lower deck. The detector coil shield can was too large for the chassis, hence it was replaced by one cut down from a long I.F. coil shield.

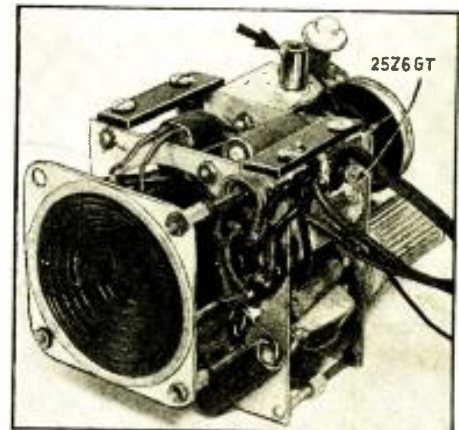

Fig. D. Chassis lying on its side, shows the relationship of the speaker to the rest of the set. The arrow points to the shaft coupling which fastens the helm to the tuning condenser shaft.



Fig. E. Pulling the right-hand cord increases the volume; pulling the left-hand cord decreases it. The drum set screw permits it to be adjusted in order to keep the cords from working off the cap.

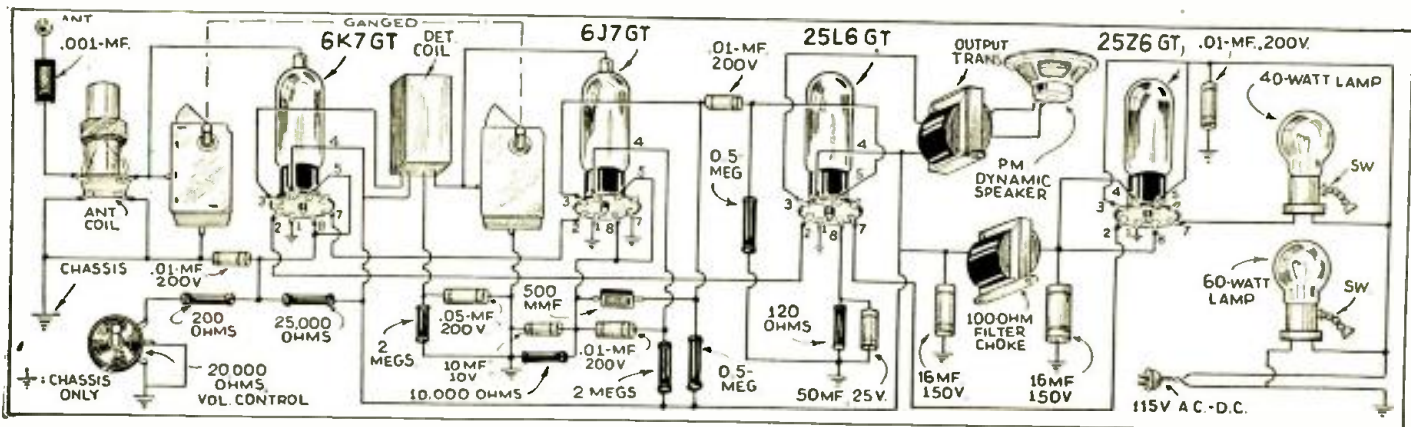

Fig. 2. Pictorial diagram. The tube filaments must be wired in the exact sequence shown, with the detector tube closest to ground potential.

HIGH-FIDELITY GOES TO TOWN!

The first in a line of high-fidelity receivers is the model HF-1. Information concerning its special features, several circuit details of which are described for RADIO-CRAFT readers by RCA engineer Zaun, is important to Servicemen.

W. J. ZAUN



Fig. A. High-quality phono recordings are best appreciated when reproduced through a radio set having wide frequency response—as for instance the HF-1 high-fidelity pushbutton receiver illustrated here in conjunction with a record player (which plugs into a phono jack provided for it).

onstration, installation, adjustment, and operation of higher-fidelity instruments.

FIDELITY

In the HF-1, the frequency response is specified to a high standard, and the remaining performance characteristics are adjusted to provide an instrument that is fool-proof as regards operation and control, and yet retain satisfactory performance.

Over-all response obtained is uniform in the range from 50 cycles to somewhat over 7,000 cycles, when the receiver is set for "Broad" response. Full realization of this superior range is naturally limited by the quality of transmission and the type of program being used by the particular station received. A low-frequency compensating network is used in conjunction with the audio volume control, and the audio gain chosen to give normal room volume and best tone quality when the control is operated near to the compensation point. The audio system consists of push-pull output, push-pull driver stage, and single 1st audio input stage with phase-inversion type of coupling to the

(Continued on page 180)

THE comparatively low-price, RCA model HF-1 high-fidelity pushbutton-type receiver (shown above in Fig. A) represents the beginning of a series of instruments, designed principally to produce the finest possible tonal response. Although the attainment of a wide and uniform range of audio response has been within engineering and manufacturing capability, the popularity of higher-fidelity receivers has previously been limited by the public demand for the best in sensitivity,

ideal selectivity, and freedom from interference.

The average radio technician no doubt appreciates that extension of high- and low-frequency response in higher-fidelity instruments involves an assortment of commercial as well as engineering factors. It is felt, however, that a résumé of the various technical considerations and their relations to practical application in the customer's home may be timely in augmenting the education necessary for the proper dem-

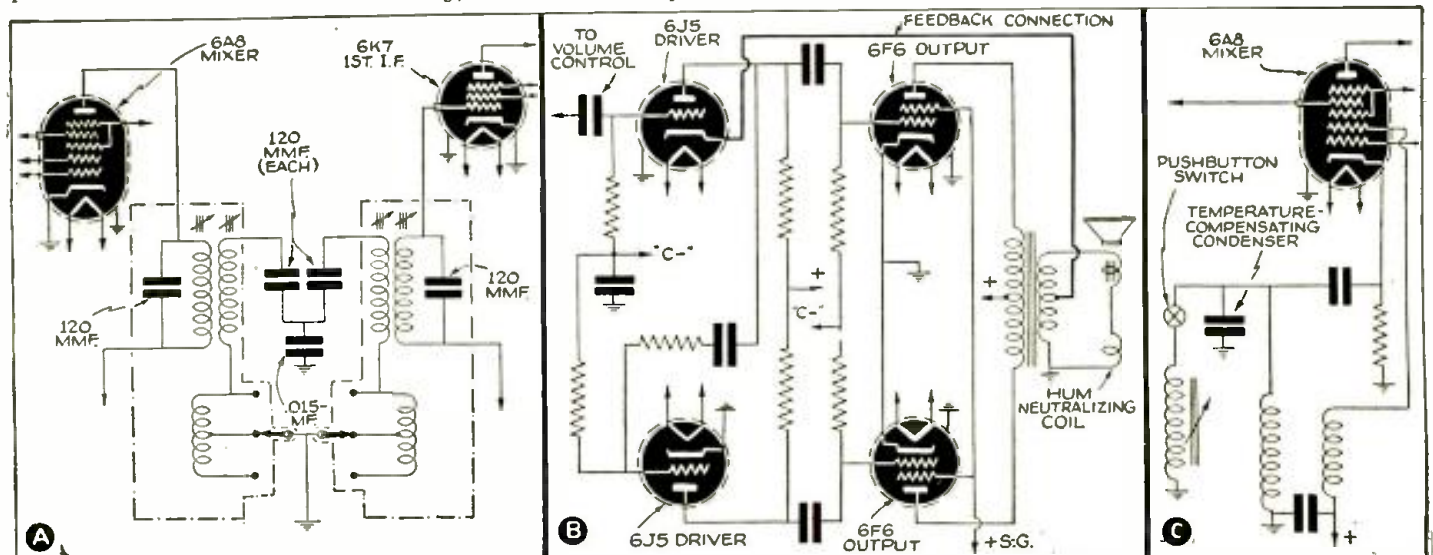

Fig. 1. The complete circuit of this receiver is shown on pg. 159A. To achieve high-fidelity response it incorporates circuit features as follows: (1) Link circuit in preselector system to provide adequate attenuation against image response, I.F. heterodyne combinations, and cross-modulation (circuit A, above). (2) Inversed-feedback with push-pull amplifier (B, above). (3) Temperature-compensated oscillator circuit to offset frequency drift and consequent distortion (C, above). (4) Fidelity range extended at both low and high ends. (5) Pushbutton tuning for 8 stations to insure accurate adjustment to exact frequency. (6) Magnetite-tuned transformers to give permanent and stable tuning of I.F. system. (7) Selectivity control to provide for varied conditions of use. (8) Aurally-compensated volume control to correct for ear characteristics at lower volume levels. (9) Phonograph input jack (at rear, but controlled from main switch on cabinet); utilizes the high-fidelity A.F. system of the set to "play" high-quality phono records.

AN OPEN LETTER TO THE RADIO INDUSTRY

from HUGO GERNSBACK

Now that we are in the midst of a major depression I believe that I violate no confidence when I state that the Radio Industry as a whole has been very hard hit not only due to lack of sales, but mainly due to the fact that the industry has produced nothing of outstanding novelty that the public really desires and wishes to buy

. . . Depression or no depression, if people want things badly enough they will buy them at the expense of other things which they do not need as badly.

As I have stated many times I do not take any particular joy or pride in a score of radio predictions which I made in the past; many of which have come to pass and are now accepted as part and parcel by the Radio Industry. Thus I predicted and showed illustrations of the first Radio Console. I predicted the first Radio Set with Self-contained Loudspeaker (remember when we used to have separate loudspeakers?). I predicted the first Single-Control (1-knob) Set when we used to have 10 or 15 knobs; but why go on with the list? Back numbers of my various publications give the facts to whoever wishes to look for them.

A BOON TO ELDERS

At the present time there is a distinct use for a special type of radio set which, believe it or not, is not being made today. Large newspapers, notably *The New York Times* and other metropolitan newspapers, have been flooded for months with letters from parents and educators who bemoan the fact that their young children, ages, usually 6 to 12, have become such addicts to "the radio," and particularly to certain types of adventure programs and others, that parents are becoming more and more exasperated on account of this condition. In lengthy letters to the editors of newspapers they complain that the children will sit for hours before the radio forgetting to do their home-work and oblivious to anything except the latest radio serial. Anyone who has young children in his home will know exactly what this means and what a dissension the situation creates, and how the children are actually failing to do their home-work, practice the piano or violin and, worst of all, instead of going to bed they spend untold hours before the radio set, making them hollow-eyed and interfering with their health. These are facts which can easily be checked by anyone interested enough.

Now then, let it be understood that I have no idea whatsoever in condemning the broadcasting companies for sending out these programs. After all, if the children are interested in the programs they must be good enough to hold their interest. It is not in my mind at all to denounce the broadcasters or radio in general. Indeed, nothing is further from my mind. It is exactly as if I were to condemn an excellent candy manufacturer because he makes candy.

The point of the entire controversy is that there can be too much of a good thing. There can be too much listening to radio to the detriment of one's education and health, just as a child can get too much good candy and get ill from it too. The fault, therefore, does not lie intrinsically with the radio program itself but rather with the radio industry. If my child eats too much candy there is an easy way of stopping it—I can give him one piece and lock the rest up where he can't reach it. With radio this, unfortunately, up to now was not possible, unless you disconnected the entire radio set and put it into a closet which you locked. This, however, is a foolish procedure when it can be done so much easier.

The answer to the entire problem is ridiculously simple. So much so, that it is difficult for me to understand why the radio industry has not turned out by the thousands, long before this,— "lock-radios"!

"LOCK-RADIOS"

Here then is a radio set that will appeal to every parent, to every educator, to every school. Indeed it has dozens of other uses, apparent to any one. I have shown on this page a number of simple table sets which can easily be provided with special locks for special purposes.

Observe the first set (Fig. 1) which instead of the usual off and on switch apparently has no switch at all—but instead has a key. You insert the key which turns the set off or on just as the knob did, but unless you have a key that fits you cannot operate the set.

Next on the list we have the radio set (Fig. 2) that has no key but utilizes instead a combination lock. Such combination locks are on the market today and you probably have seen them. They usually have 4 or 5 rollers parallel to each other, each one equipped with a number. Unless you know the combination the lock will not work. In this case, of course, the lock is attached to the off and on switch on the inside.

The third variation (Fig. 3) is to have about 6 miniature pushbuttons; the right combination, when pushed or twisted completes the circuit, whereupon the set becomes operative.

There are of course, other variations of this scheme and I have refrained purposely from showing a safe-lock combination tumbler as it probably is too expensive. Incidentally this lock is too much like a radio dial and therefore should not be used.

(Continued on page 184)

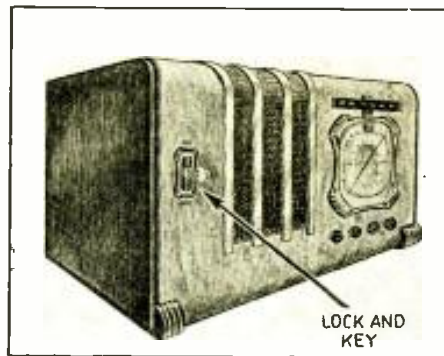

Radio set with lock and key on-off switch.

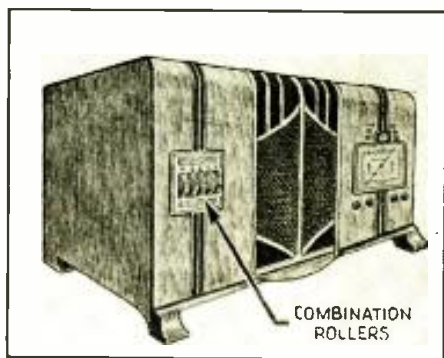

To turn the set on you must know the combination.



Set with pushbutton combination switch.

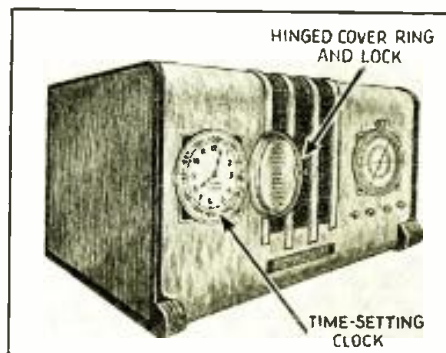

This set turns on or off at any pre-set time.

THE PRINCIPLES OF NOISE-

Considerable qualitative information is available on the subject of antenna systems been published to indicate why and how, and to what extent, proper design and happy therefore to here present what is believed to be an important contribution to

J. G.

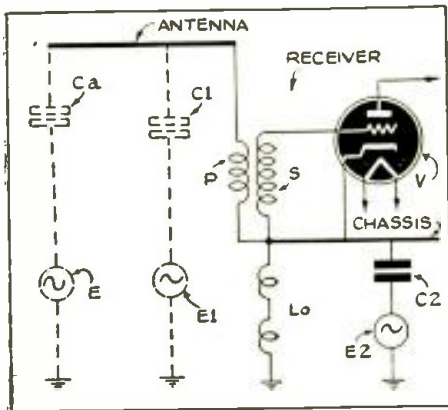

Fig. 1

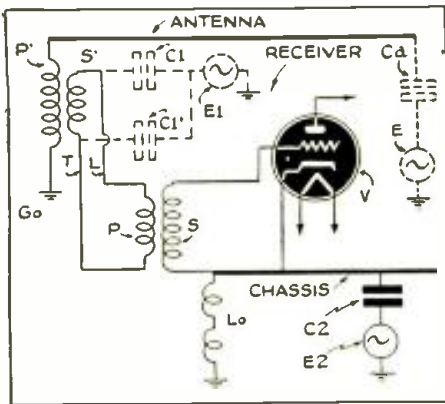

Fig. 2

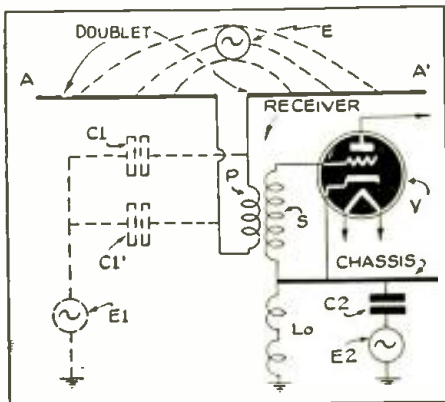

Fig. 3

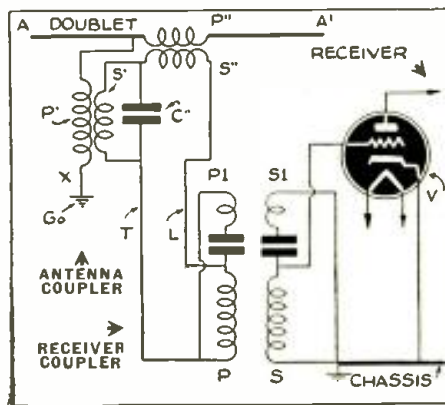

Fig. 4

THE rapid progress made in the design of radio receivers for greater fidelity was not matched by the improvements in the signal pick-up devices until a few years ago when the necessity of reducing noises from other electrical apparatus became more and more apparent.

Radio receivers, even the less expensive ones, have, generally speaking, more reserve of sensitivity than can be used on account of the noise that accompanies the signal from man-made static. This holds true almost everywhere, but particularly in cities.

If it were possible to place the antenna in a space where there was nothing but Hertzian waves from the transmitting stations, then the solution of the noise problem would require a transmission of the signal picked up by the antenna, to the radio set, through a channel that is "air-tight," so to speak, against any external electrical influences surrounding it. Then noise-free reception would be accomplished.

Such a system, comprising an antenna, a transmission line and 2 or more coupling units, is called in this article a "Noise-Reducing Antenna System."

WHY A "NOISE-REDUCING" ANTENNA SYSTEM?

Hence, it is well to keep in mind right from the very start that a noise-reducing antenna system is not an amplifier, nor must it be necessarily a longer antenna that will deliver a higher signal level to the receiver. It is essentially something that will give you a signal *with less noise*.

Unless your set is so insensitive that it requires a strong pick-up to increase the DX reception, then a noise-reducing antenna system should permit you to open up the gates and let the full gain of the set come into play, because there will be no noise to amplify together with the signal. Hence, the DX fan will be

able to receive and understand signals too weak to override the noise otherwise. The music lover will be able to use the full audio range without constant hisses and grinding noises accompanying his favorite local programs, as received by high-fidelity radio sets.

These remarks should be well pondered over by the listener, the Serviceman and the manufacturer alike, in order to appreciate the advantages of noise-reducing systems.

We are aware of the fact that there are only a small percentage of really *effective* noise-reducing systems on the market, and also a number of fakes which may have coils, condensers or resistors that merely displace a bit of air in their containers, or merely a couple of soldered joints.

In order to understand how the noise elimination takes place, let us examine how electrical disturbances enter a radio receiver.

ABC OF NOISE PICK-UP

Consider the equivalent circuit of a radio set represented schematically in Fig. 1. The antenna can be considered as a generator E, in series with condenser Ca, which forces a current through the primary P of the input transformer PS to the first tube V of the set. The current will continue to earth via the ground lead, having distributed inductance Lo and also via the power supply line through the capacity C2 which is an actual condenser in many sets or simply the capacity between windings of the power-pack transformer. In A.C.-D.C. sets there is a solid metallic connection.

This signal current will induce a voltage across the secondary S, and the tube V.

Now consider a source of interference E1 having an effective capacity coupling to the downlead, represented by condenser C1. Current will flow through C1 and P to ground, as before

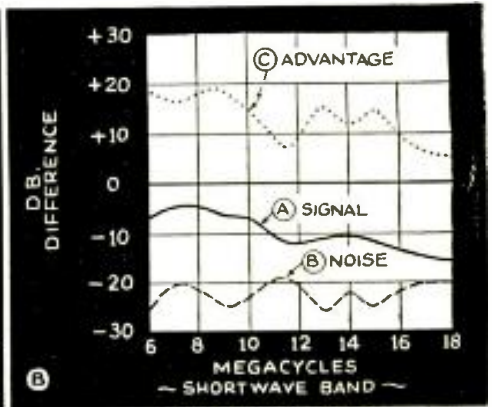
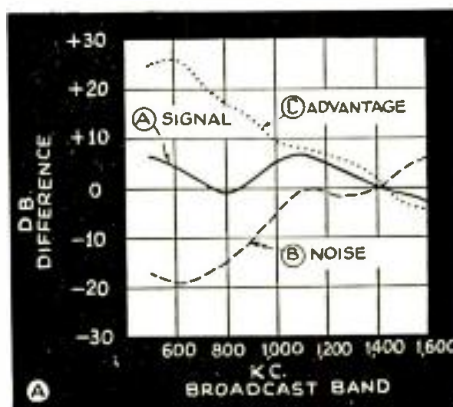

Fig. 5

REDUCING ANTENNA SYSTEMS

to improve the signal/noise ratio but very little quantitative, factual material has installation of noise-reducing antenna systems are effective. RADIO-CRAFT is very radio literature by an authority in the vanguard of antenna development.

ACEVES

and interference voltage will appear across S and the tube V (Fig. 1).

But the major source of interference comes via the power line.

Electrically, it is equivalent to a generator E2 in series with the chassis, either directly as in A.C.-D.C. sets, or through a capacity C2 (Fig. 1).

This generator will force current through C2 and it reaches the chassis. Then it has 2 paths to return to earth; the first one is through the ground connection which has an effective inductance L_0 . This lead may not be altogether free from interference because the conduit system, BX cable, or other so-called "grounds" available may carry transient currents from other power apparatus, such as from elevator machinery, etc. The second path includes the primary P, the downlead and the antenna, returning to earth via Ca, that is, by radiation into space. It is this current that in traversing the primary P induces an interference voltage in the secondary S and into the tube V.

When interference of this type is heard, if the antenna post of the set is disconnected entirely, the interference will stop at once, which is what would be expected from the explanation previously given.

Other minor sources of interferences, such as direct pick-up from the set itself, are not worth mentioning. Likewise, those which are uncontrollable, such as the interference picked up by the antenna itself.

From the foregoing, it will be seen that a noise-reducing antenna system is a "network" which separates these inter-coupled circuits.

NOISE REDUCTION—MARCONI-TYPE ANTENNA

In Fig. 2 is shown schematically a noise-reducing system for broadcast wavelengths. It will be noted that the 3 paths are completely separated. The signal voltage, shown as E, will force a current through the primary P' of antenna transformer P'S' by capacity coupling, generating a voltage across S'. A transmission line or twisted-pair TL connects S' to the primary P of the set transformer, delivering a signal voltage across S to the tube V.

The interference voltage E1 having equal capacities to the 2 wires of the line cannot send a current through P or S' and cannot gain access to the tube V. Likewise, the source E2 cannot send a current through P or S of the set coupling transformer as there is no circuit and the current through C2 must go back to ground via L_0 . This is the essence of a noise-reducing system for use with a Marconi-type (T or inverted-L) antenna, that is, acting as an ele-

vated capacity. Variations from it will be discussed later.

NOISE REDUCTION—DOUBLET ANTENNA

For the reception of short waves, a doublet antenna is much better from the standpoint of noise reduction. In Fig. 3 it is obvious that the interference sources E1 and E2 cannot act upon the transformer P-S for the same reason as in Fig. 2, i.e., there is no complete circuit except through the distributed capacities between windings; lowering this, improves the signal/noise ratio.

A screen between windings eliminates direct capacity coupling, but does not eliminate a resulting magnetic coupling from current going around the turns of winding P, through distributed capacity to the shield. A symmetrical construction may produce a more complete neutralization of this curious effect, and isolate the path of the interference currents. The signal is like a voltage E between the 2 branches of the doublet, and the transmission line will transfer this voltage across P and S to the tube V.

NOISE REDUCTION ON ALL WAVES

By combining the features of Figs. 2 and 3, we have a complete all-wave noise-reducing system as shown in Fig. 4, in its essentials, complete with antenna coupler.

The antenna AA' acts as a doublet with an S.-W. transformer P"S" at the gap; its output voltage to feeder TL forces a current through P1 and delivers an S.-W. signal across S1 to tube V of the set. The same wire AA' acts as a "T" or Marconi antenna for the broadcast band, by sending a current through the primary P' of the long-wave transformer P'S' to a local ground Go. The secondary S' will deliver the required voltage across the transmission line and, of course, to the set via P-S. The condenser between P1 and P, also the condenser C'', having high reactance for long waves, do no harm for broadcast frequencies, but offer a low-reactance path to the high frequencies from the short-wave transformers P"S" and P1S1.

In the receiver coupler, Fig. 4, there are 2 transformers: P-S for low frequencies and P1S1 for high frequencies, with their windings in parallel. Condensers are placed in series with P1 and S1 to divert the low frequencies.

(Note that, in Figs. 4, 6 and 7, both the antenna and the receiver couplers are external to the radio set.)

Summing up, we see that the essence of the noise-reduction system is to separate the paths of the signal and the interference flow of energy. This requires the use of a doublet for short

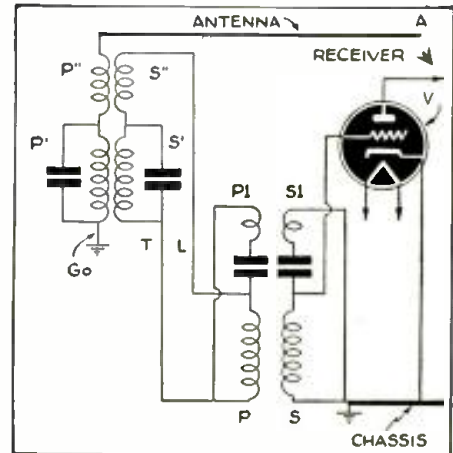

Fig. 6

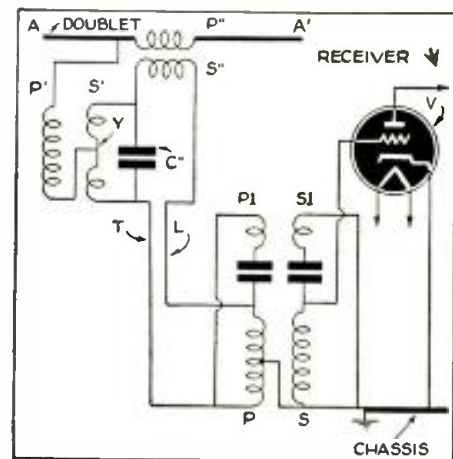

Fig. 7

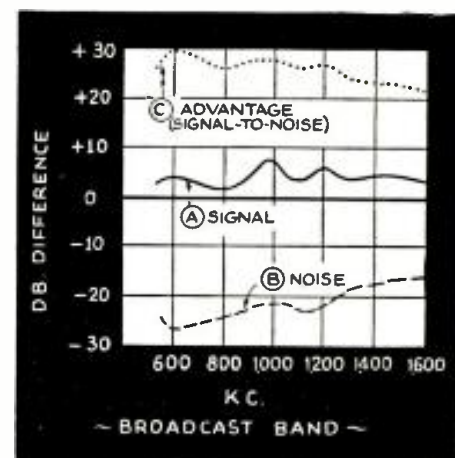
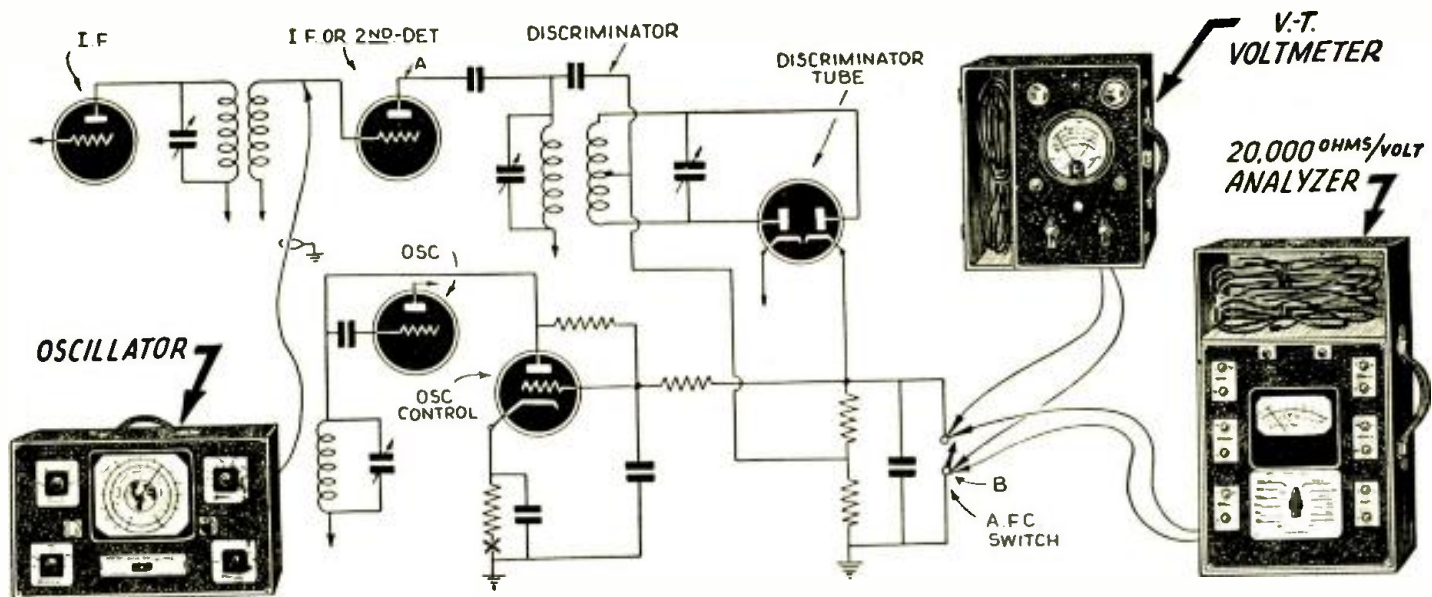

Fig. 8

waves and a separate ground and "T" antenna for the longer waves, such as in the standard broadcast band.

CAN NOISE-REDUCTION BE DEMONSTRATED?

Laboratory circuits have been devised for the purpose of measuring the amount of noise reduction effected by (Continued on page 177)



A.F.C. ALIGNMENT MADE EASY

Proper Automatic Frequency Control adjustment is imperative in many modern radio sets. Read how easy it is if correct tools and procedure are employed.

THE automatic tuning devices now being used in radio receivers are subject to inaccuracies and many times do not tune the receivers correctly. Therefore, it becomes necessary to use an *automatic frequency control* system to insure perfect tuning.

These A.F.C. circuits normally consist of a *discriminator* tube and "oscillator" or *control* tube. A typical circuit is shown above.

As a signal passes through the I.F. section of the set, if the oscillator is not tuned to the exact frequency, a voltage is developed across the cathodes of the 6H6 discriminator tube. If the oscillator is tuned to one side of the I.F., a *positive* voltage will result; if it is tuned to the other side of resonance, the voltage will be *negative*. Whatever voltage is developed is, in turn, impressed on the grid of the oscillator control tube varying its mutual conductance; and in turn, adding or subtracting from the inductance in the oscillator tube circuit, —thereby correcting the tuning and assuring absolute resonance. The entire action of such A.F.C. circuits depends upon perfect adjustment of the discriminator transformer.

ALIGNING I.F. AND R.F.

In attempting to align a receiver using A.F.C., the set should be first adjusted in the conventional manner entirely neglecting the A.F.C. circuit. A good stable oscillator should be connected to the grid of the 1st-detector and ground. An output meter should be connected across the speaker terminals or from plate-to-plate on the output transformer. The I.F. trimmers should then be adjusted for maximum output reading. This procedure should

be checked a second time in order to insure maximum accuracy.

After the adjustment of the I.F. transformers, the oscillators should be connected to the antenna and ground terminals and the R.F. section carefully adjusted. In making all of the above adjustments, the A.F.C. switch should be in OFF position so that there is no controlling action in the oscillator circuit. If, in some cases, the manufacturer does not supply a switch for eliminating the A.F.C. circuit, a short-circuiting switch should be inserted across the cathodes of the discriminator tube, or the control-grid on the oscillator control tube may be grounded to the chassis. Care should also be used in the adjustment of the I.F. and R.F. sections so that the oscillator signal voltage is kept as low as possible, and the volume of the receiver turned up as high as possible in order to prevent any action of the automatic volume control circuit.

ALIGNING A.F.C.

With the completion of the above procedure, the set is perfectly aligned with the exception of the A.F.C. circuit. The signal generator should then be set to the exact I.F. at which the set is now adjusted. The signal should be fed into the grid of the 2nd-detector or I.F. stage from which the discriminator transformer is coupled as shown at A above. A vacuum-tube voltmeter should be connected across the A.F.C. switch or discriminator tube cathodes with the switch open as shown at B in diagram. The trimmer on the secondary of the discriminator transformer should then be detuned slightly. The trimmer on the primary should next be adjusted for maximum voltage reading on the

vacuum tube voltmeter. Next, the secondary trimmer should be adjusted until an absolute zero voltage condition exists. Extreme care is required in this adjustment since a positive voltage can be obtained on one side of resonance and the negative voltage will be obtained on the other side of resonance.

When this zero-voltage condition is obtained, the discriminator transformer has been tuned to resonance and all adjustments have been made. If a vacuum-tube voltmeter is not available, a 20,000 ohms/volt analyzer can be used in its stead. Under no conditions should any attempts be made to measure the discriminator voltage with a 1,000 ohms/volt instrument. Such readings would only be a small portion of the actual circuit potential and the absolute zero adjustment necessary, will be much too difficult to read accurately.

FINAL CHECK

As a final check on the alignment, the 10-milliamper range of an analyzer should be inserted in series with the cathode of the oscillator control tube as shown at point X above. One model of Weston socket selector unit provides a quick, easy method of breaking into all such tube circuits in making current measurements. With the meter inserted in this manner, the A.F.C. switch should be thrown "ON" and "OFF"; *if the discriminator circuit has been properly adjusted, there will be no change in the meter indication.*

We hope that this pictorial type of presentation will help Servicemen to visualize the procedure.

This article has been prepared from data supplied by courtesy of Weston Electrical Instrument Corp.

NEW SET-UP FOR PRACTICING CODE

Beginners—even "Y.L.'s"!—may learn the radio code by following any one of several systems, some of which are easier than others.

ELI M. LURIE

ONE of the most interesting hobbies, both from the viewpoint of the experienced operator and also of the interested broadcast listener, is the reception of code signals. You find the field of this entertainment so diversified and enjoyable as to be thoroughly enthralling.

Unfortunately for the beginner, he (or she!) usually finds it difficult to master the code. Usually the beginner learns the code so that he can transmit with perfect ease and sometimes even with great rapidity but conversely on receiving code signals, he finds it very difficult to transcribe the

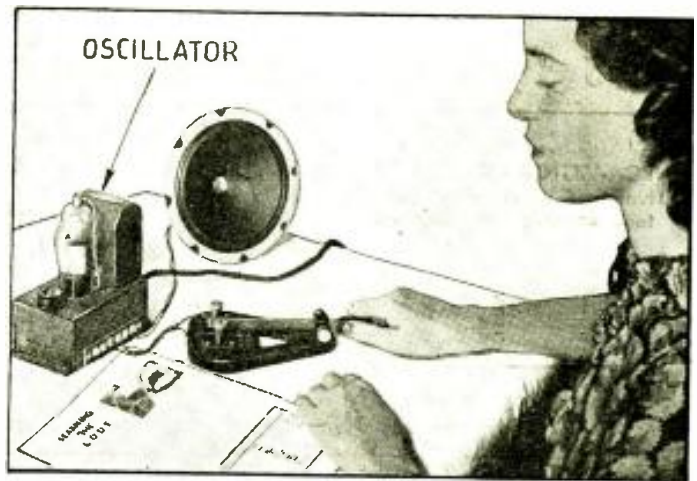

Fig. A. "Y.L." finds code practice easy, using a "sideswiper" to key the adjustable-tone A.C.-D.C. oscillator (shown connected to a handy loudspeaker).

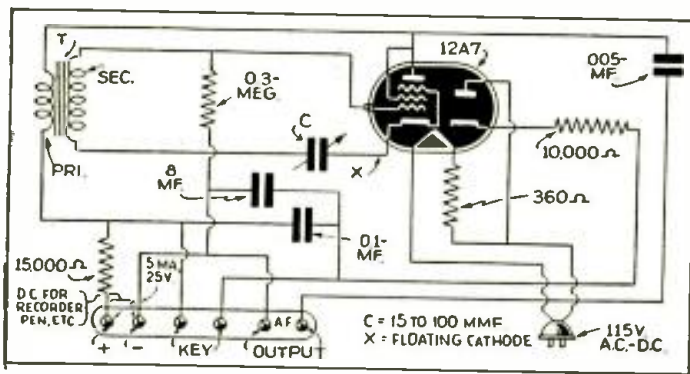

Fig. 1. The A.F. oscillator uses an improved circuit.

signals into actual letters. Oftentimes, the beginner learns the code in the wrong way. He will usually start by saying the letter "a" is dot, dash; the letter "b" is dash, dot, dot, dot; the letter "c" is dash, dot, dash, dot, etc. The most important function in learning the code is to learn it as it actually sounds when receiving code from the air.

Instead of saying the letter "a" is dot, dash, the letter "b" is dash, dot, dot, dot, etc., he should say "a" is dit, dah; the letter "b" dah, dit, dit, dit; the letter "c" is dah, dit, dah, dit, etc., so that he actually learns the code as he will hear it.

Another aid in learning the code is not to learn the alphabet as it is customarily written but to learn the letters as they numerically appear. Thus, the letter "a" is dot, dash; the letter "w" is dot, dash, dash; the letter "j" is dot, dash, dash, dash; the number 1 is dot, dash, dash, dash, dash.

After the pupil has mastered the code by tones as explained above, and can receive any letter by merely looking
(Continued on page 181)

RADIO WITTIQUIZ

FREE — A 1-year subscription to RADIO-CRAFT to each person who submits a Wittiquiz that in the opinion of the Editors is suitable for publication in RADIO-CRAFT. Read the following Wittiquizzes; can you spot the correct answers? Now send in your idea of one or more good Wittiquizzes.

(117) Is a depolarizer—
(a) An instrument used by Admiral Byrd? (b) An antenna support? (c) A chemical used in a primary cell to prevent polarization caused by formation of excess hydrogen at the carbon electrode?

(118) A microphone button is—
(a) A switch to turn the microphone off and on. (b) A type of button an announcer wears. (c) A carbon element attached to the diaphragm of a microphone.

(119) Is a wet electrolytic condenser—
(a) A condenser that has been in water? (b) A device for drying wet electrons? (c) A leaky condenser? (d) An electrolytic condenser which uses a liquid electrolyte?

(120) Everyone knows a wave-change switch is—
(a) A switch for controlling ocean waves. (b) A switch used in a receiver

or transmitter to change from one waveband to another. (c) An automatic volume control. (d) A switch that sends the radio wave back to the transmitter.

LAWRENCE TUVESON

(121) Radio men know that *mho* is—
(a) A commercial operator. (b) A type of loudspeaker. (c) The unit of conductivity. (d) An electrical measuring device.

(122) A lodestone is—
(a) Used in phono pickups. (b) A natural magnetic substance. (c) Used for controlling the voltage on the filaments of tubes. (d) A new type of dry battery.

AUBREY K. HAINES,
New Brunswick,
Canada.

(123) The spider is—
(a) A mysterious creature that haunts radio receivers. (b) Another name for the springs supporting a

microphone unit. (c) A device for holding a speaker cone centered. (d) A phonograph pickup.

(124) An electron gun is—
(a) Another name for an ultra-short-wave transmitter. (b) A Buck Rogers invention. (c) The cathode, focusing electrode and anode which shoot the electrons through a cathode-ray tube. (d) A gaseous rectifier.

(125) A slider is—
(a) A tuning dial. (b) A man who gets home on a steal in baseball. (c) The slang term for a broad-tuning radio set. (d) A movable contact on a coil to vary its length.

(126) A tweeter is—
(a) A silly giggle. (b) A small speaker used to reproduce high-frequency notes. (c) The microphonic noise often heard on poor receivers. (d) An automatic telegraph sender for distress signals.

(Continued on page 179)

RCA-VICTOR MODEL HF-1 (Symphony) HIGH-FIDELITY 8-TUBE SUPERHET.

RCA-VICTOR MODEL HF-1 (Symphony) High-Fidelity 8-tube Superhet. Extended-range (540-1,550 kc.) B.C. receiver; pushbutton tuning; A.V.C.; output (undistorted), 10 watts; 12-in. dynamic speaker; socket for aligning "eye" tube; phono jack; selectivity control; tone control; temperature-compensating condenser; magnetite-core coils; inverse feedback; frequency range, 70-7,000 cycles.

(See Data Sheet 236 for additional information)

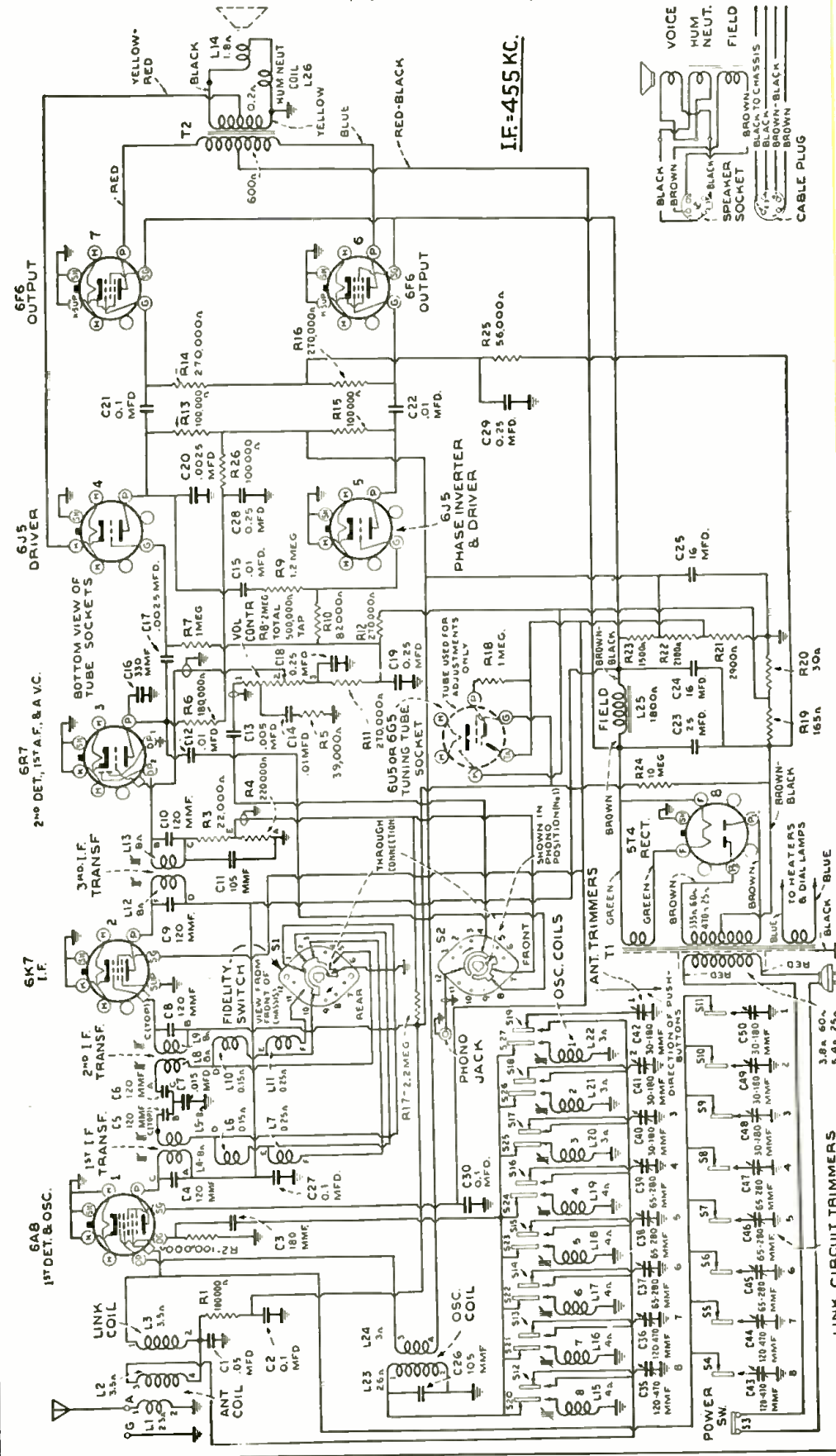

- | | | |
|-------|--|--|
| No. 1 | Phono operation, with minimum high-frequency response. | Connects phono to high side of volume control. Connects C12 (0.01-mf.) from plate of 1st A.F. tube to chassis. Disconnects radio set by short-circuiting diode load R4. |
| No. 2 | Phono operation, with maximum high-frequency response. | Same as position No. 1 except that C12 is disconnected. |
| No. 3 | Radio operation, with maximum selectivity, minimum high-frequency response and minimum fidelity. | Short-circuits phonograph. Connects diode load to high side of volume control. Connects C12 (0.01-mf.) from plate of 1st A.F. tube to chassis. Grounds low end of L5 and L8. |
| No. 4 | Radio operation, with maximum selectivity. | Same as position No. 3 except that C12 is disconnected, resulting in more "highs" than position 3. |
| No. 5 | Radio operation, with medium selectivity and medium fidelity. | Same as position 4 except that ground is moved from L5 to L8 to low end of L6 and L10. |
| No. 6 | Radio operation, with minimum selectivity and full-range fidelity. (clockwise) | Same as position 5 except that ground is moved from L6 and L10 to low end of L7 and L11. |

Purpose and Function of the 6 Positions on Fidelity Switch

RCA-VICTOR MODEL HF-1 (Symphony) HIGH-FIDELITY 8-TUBE SUPERHET.

RCA-VICTOR MODEL HF-1 (Symphony) High-Fidelity 8-tube Superhet. Extended-range (540-1,550 kc.) B.C. receiver; pushbutton tuning; A.V.C.; output (undistorted), 10 watts; 12-in. dynamic speaker; socket for aligning "eye" tube; phono jack; selectivity control; tone control; temperature-compensating condenser; magnetite-core coils; inverse feedback; frequency range, 70-7,000 cycles.

(See Data Sheet 235 for additional information)

I. F. Alignment Procedure

Cathode-ray Alignment is the recommended method for Model HF-1. **Output Meter Alignment.**—If an output meter is used, connect it across the voice coil, and turn the receiver volume control to maximum. **Test-oscillator.**—For all alignment operations connect the low side of the test-oscillator to the receiver chassis, and keep the output as low as possible to avoid A.V.C. action.

For additional details, refer to booklet "RCA Victor Receiver Alignment." **Push in button 8, and adjust the No. 8 trimmers and core to a quiet point near 600 kc. Leave the button pushed in for the following operations:**

Steps	Connect the high side of test-oscillator to—	Tune test-osc. to—	Turn Fidelity switch to—	Adjust the following for max. peak and symmetry—
No. 1	6K7 I-F grid cap, in series with .001 mfd.	455 kc (20 kc sweep)	---	L12 and L13 (3rd I-F transf.) (Refer to curve "A")
No. 2	6A8 1st-det. grid cap, in series with .001 mfd.	455 kc (20 kc sweep)	Position 4 (from left)	Turn L4 and L5 (1st I-F) out as far as possible. Peak L8 and L9 (2nd I-F), and then L5 and L4. Readjust L8 and L9 slightly if necessary. (Refer to curve "B")
No. 3	Turn selectivity switch to position 5. Response should be like curve "C".			
No. 4	Turn selectivity switch to position 6 (full clockwise). Response should be like curve "D".			
No. 5	Follow "Adjustments for Electric Tuning".			

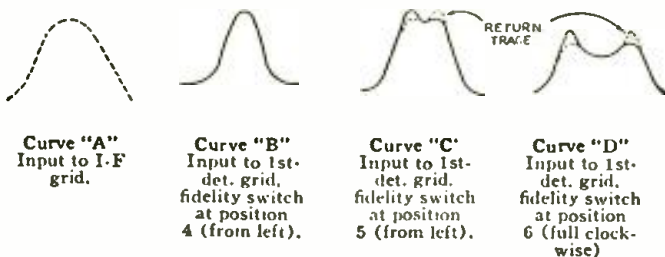

Adjustments for Electric Tuning

1. Make a list of the desired 8 stations, arranged in order from high to low frequencies. It is preferable to select strong local high-quality stations within a radius of 100 miles.
2. Insert an RCA-6U5 or 6G5 Magic Eye tube in the 6-prong socket on the chassis. Use an insulated screwdriver or alignment tool (such as RCA Stock No. 31031) for all adjustments. LEAVE THE FIDELITY SWITCH IN POSITION 3 OR 4 WHILE MAKING ADJUSTMENTS FOR ELECTRIC TUNING.
3. Remove the antenna lead-in from the "A" terminal and wrap it once around the green lead to the top cap of the 6A8 grid. (This provides capacity coupling between the antenna and the 6A8 grid.)
4. Push in button No. 1 and turn oscillator core No. 1 to bring

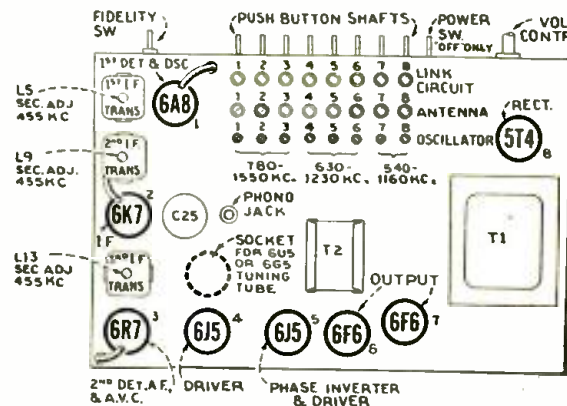

5. in the first station on the list. Adjust the core carefully for peak output as indicated by the Magic Eye. Adjust link trimmer No. 1 for max. output.
6. Remove the antenna lead-in from the 6A8 grid lead and connect the lead-in to the "A" terminal. Adjust antenna trimmer No. 1 and link trimmer No. 1 for peak output as indicated by the Magic Eye. (Clockwise rotation of cores and trimmers tunes the circuits to lower frequencies, and counter-clockwise adjustment tunes the circuits to higher frequencies.)
7. Push in button No. 2. Adjust oscillator core No. 2, antenna trimmer No. 2, and link trimmer No. 2 for the second station in the same manner.
8. Follow the same procedure for the remaining stations.
9. After tuning-in 8 stations as specified above, leave the antenna lead-in connected to the "A" terminal, and carefully readjust each of the oscillator cores for peak output on the respective stations.
10. After the set is installed and connected to the customer's antenna, make a final readjustment of the antenna and link trimmers.
11. The Magic Eye should be removed from the chassis after completion of the electric-tuning adjustments.

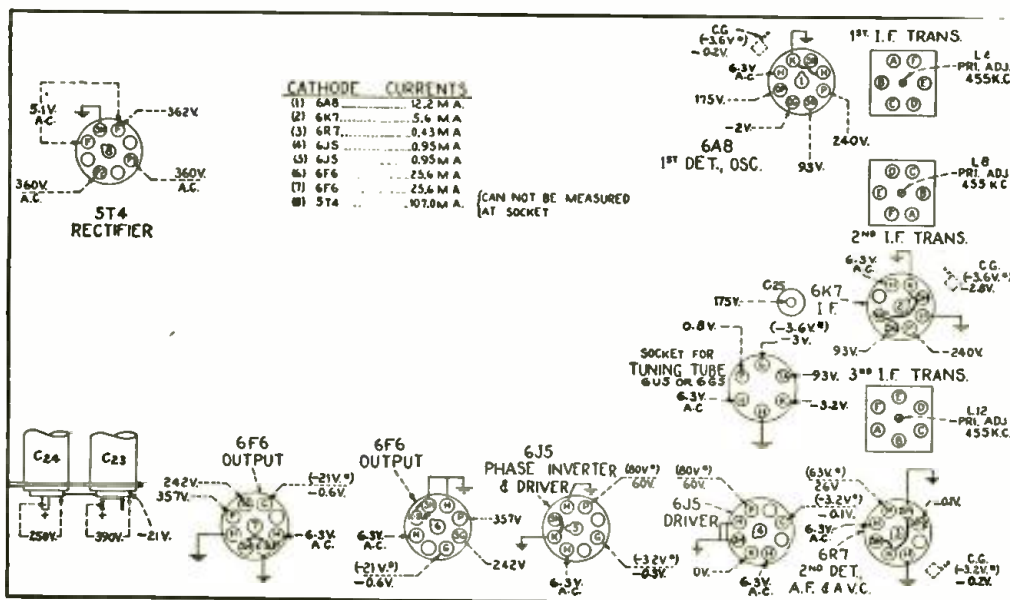

RCA-VICTOR Symphony model HF-1 high-fidelity receiver. There are no dials. Eight stations are pre-tuned and set for automatic pushbuttons. A 9th button turns the instrument off. Uniform reproduction of from 50 to 7,000 cycles, with a peak output of 12 watts is claimed.

Fig. 4. Socket voltages. Measurements made to chassis unless otherwise indicated and with Magic Eye in socket. Measurements made with all pushbuttons out, volume control turned to minimum, using 1,000-ohm-per-volt meter, having ranges of 10, 50, 250, and 500 volts. (Use range above the specified measured voltage.) Values should hold within approximately ± 20% for 117-volt, 60 cycle supply. Note: values with (*) are operating voltages. Values not starred are actual measured voltages.

CUTE LITTLE SONS



Nipper, perky pup of "Master's Voice" fame, has had a dividend. Her pups will warm their tails on new RCA-Victor tubes, of which they are trademark. Tubes will sell through wholesalers handling the set, phono & record lines; will cash in on long-established ad value of world-famed pooch.

\$'s & #'s

CENSUS

ACCORDING to figures accepted by NAB, 4-A & ANA, 82% of U.S. homes have radio. Breakdown shows 69% in country areas, 91% in cities. (Any place of over 2,500 was called a city!) 1936 figures showed about 73.5% of homes thus equipped. Auto-radios, not included, were put at 5,000,000, and homes with two or more sets were merely classified as radio-equipped, which accounts for differences between no. of radio homes & no. of radios in use.

EXPORTS

Exports upped in 1937, radio dollars coming into the U.S. to the amount of \$32,357,417. More than half was for sets; tubes, next biggest item, at 4 million dollars; xmitters, etc., 3rd, with about 2½ million dollars.

Figs. for '36 totaled \$28,284,251, including set sales only \$300,000 below '37. Total increase was 14.4%.

(Continued on page 170)

"F.D.R. & US"

AMUSING result of *Radio Trade Digest* questionnaire, sent to 3,200 radio firms. Those whose business is on the upturn credit "Better products & hard work"; those whose business is not so torrid blame "Interference by the Administration." The radio boys ought to get together. Consensus of opinion will be published in these pages shortly.

TELEVISION'S HERE — IN THE SAME OLD WAY

COMPANY DENIES STOCK SALE PLANS, THEN INCORPORATES FOR MILLION;
9 OF 10 STORES FAIL TO STOCK TOUTED LINE

IN late May, radio magazines & columns (including that of the erudite *N. Y. Times*) went off the deep end for television. Springboard of the fearsome plunge was announcement of Communicating Systems, Inc. (N.Y.C.) that sets would be put upon market at \$125-\$175. President S. M. Saltzman & V.-P. C. H. Sterenfeld of CSI stated that no stock promotion was contemplated, & *Times* gave list of 10 stores which would handle the apparatus. *Radio-Craft*, reporting advance demonstration, advised readers to lay off any stock sale.

Despite CSI officials' denials, a 1,000,000 share co. has been formed to sell stock in CSI television subsidiary, although but one of the listed stores now carries the apparatus at the price quoted. Of the other stores, one quotes \$250 price, but has no sets; another had sets, but discontinued; a 3rd, dem-

onstrated but discontinued; a 4th, does not and never did stock, but may in autumn; a 5th, 6th, 7th & 8th do not stock, but may later; the 9th expects to sell them in autumn, at \$200 & up.

(Continued on page 170)

MORE FACSIMILE

FCC has granted duplex xmitter license to Finch Labs. (N.Y.C.) for 1 kw. on 31-41 mc., to test efficacy of b'cast & facsimile on a single channel. Service is announced for Fall, following trial period. Finch representative will neither confirm nor deny that Maj. Edwin H. Armstrong (regeneration & superhets.) is Labs.' consulting engineer.

More indy stations continue to climb aboard facsimile bandwagon, though trade, as a whole, does not yet see facsimile as major factor in the industry. Among stations getting FCC okay for faesy work are KBFK, Sacramento, Calif., WBEN, Buffalo, N. Y., WCH, Newport News, Va., & Johnson-Kennedy Radio Corp., Chicago, for new 500-watter.

SALES HELPS & DEALS

MFRS.' sales helps are producing business for dealers who use them; mfrs.' deals are rounding up new outlets, pepping up old ones.

Here are some winners. Wise dealers will use them; wise mfrs. will emulate them.

Weston Contest. Over \$1,000 in mdse. offered for best answer to question on use of modern test equipment. First prize a complete Serviceman's test bench. Open to all Servicemen using special entry blank obtainable from Weston, its reps. & jobbers.

(Continued on page 170)

LAUGH OF THE MONTH:

Are Servicemen Human? Many a radio set owner has wondered whether Servicemen are human beings.

Their question is answered—and by the RCA Mfg. Co.'s press department. Announcing a series of window display figures, the co.'s publicity release says, "These figures take human form, except that their bodies represent such things as a receiving tube, a transmitting tube, a tube carton and a radio serviceman."

The italics are ours—but if somebody says "Hello, old thing," to you, he's not being British; merely accurate.

BEAUTIFUL NEW MODEL



Streamlined model with lovely chassis, as exemplified by the gorgeous gal, is feature of new RCA sets. Radio men being but human, *Radio Trade Digest* features lissome lady. Incidentally, set at left is 14-tube, hi-fi, 7-band RCA model HF-6.

Digest

MONTH IN THE RADIO INDUSTRY

SEPTEMBER 1938

NO. 1

A PLEDGE:—To give the important news of the radio industry, without fear or favor; to review major news & to draw conclusions from minor happenings; to keep the dealer informed of manufacturer & consumer trends; to help point a path to radio profits.

MORE & MORE MYSTERY



"Will it work?" & "Will the FCC permit it?" are 2 questions the trade is asking about Philco's new Mystery Control, shown here with the co.'s President, James M. Skinner. Scepticism is based on fact that remote unit (shown under Mr. Skinner's hand & in insert) is really a midget xmitter. Philco reps refuse to disclose how unit will be kept from causing inter-set interference. Is that the Mystery?

SCOOPS & SNOOPS

PHOTO recording of facsimile is done better with a gaseous discharge tube on which Finch Telecommunication Labs., N. Y. C., just got U. S. Pat. 2,123,721

Transducer Corp., N. Y. C., sends a release accompanied by a note saying not to run it; there's nothing odder than people

Shallcross Mfg. Co., Collingdale, Pa., announces new lo-leakage switch; their bulletin 500P2 describes it, if you care Dope on cold plastics & non-combustible cements, to fit mfrs' specific problems offered by Sauereisen Cements Co., Pittsburgh (15), Pa.

PRESS-AGENT OR ENGINEER?

"I'll bet you \$100 that the Philco Mystery Control never reaches the public," said an industry leader to the *Radio Trade Digest* reporter.

Asked why, he replied, "Because it will run directly afoul of the FCC. Every PMC is a miniature transmitter; it is reported that they will be tuned to about 450 kc."

Queried, Philco's representatives denied that their baby xmitters come under FCC rulings; denied that Mrs. Nextdoor's PMC will tune Mrs. Neighbor's Philco, because, "each set will be factory pretuned to its individual PMC, & therefore cannot be tuned by any other." But gave no details.

Sceptics wonder how wide a band of frequencies is available for the tuners, or whether limited production is contemplated. Mystery models will retail at \$169 & \$210, inc. antennas.

Prices of 1939 RCA phonoradios include a deck of records; co. also has new "hi-fi" Red Seal needle & their automatic record changer takes 10- & 12-inch platters, *mixed*

G-E's '39 sets have self-contained ("beam-scope") aerial, automatic program pre-selector & "keyboard touch tuning" May be a side-line in the \$21.50-42.50 ozone generators Automatic Electrical Devices Co., Cincinnati, are putting out; looks like a possible all-year seller FTC cracked down on Parker-McCrory Mfg. Co., of Casey Moe, with complaint that ads exaggerate DX powers of its set, performance of its (Continued on page 171)

Meanwhile, same sceptics say real mystery is, "How does Philco expect to get away with releasing unlicensed transmitters? Or are they just *discussing* PMC?"

OFF THE PRESS

Aviation Radio Information. RCA Mfg. Co., Camden, N. J., 132 pp. Lists of stations, in relation to their use for avigation. Free with RCA aviation radio-receivers. Sold to public by RCA for 25c.

Advanced Disc Recording. Universal Microphone Co., Ltd., Inglewood, Calif. 32 pp. Data on recording, playback, amplifiers, etc. Illustrated. Sold to public by Universal for 10c.

Engineering Data—Form 647. Centralab, Globe-Union, Inc., Milwaukee, Wis. 8 pp. Data on mfrs' brand, with curves, data on life, R.F. characteristics, etc. Free from mfr. (900 E. Keefe Ave.)

C-D Condenser. Cornell-Dubilier Elec. Corp., S. Plainfield, N. J. 20 pp. Tech- (Continued on page 170)

CHANGE IN NAMES AND ADDRESSES

Save time; save stamps. Keep up-to-date on the names & addresses of firms with which you do (or may soon do) business. Misdirected mail is always delayed, sometimes lost. Watch *Radio Trade Digest* for changes of address. Paste these changes in your card file.

National Union Radio Corp., 57 State St., Newark, N. J. Executives S. W. Muldowney, R. H. Van Dusen, J. H. Robinson, G. E. De Nike, F. M. Paret, J. J. Clune, Le Roy Schenck, at above address.

Additional New Offices:—

45 Spring St., Newark, N. J. Pres. H. R. Peters, H. G. Butterfield, A. A. Priest, R. E. Booth at above address. Engineering & Research Headquarters remain at the State Street address; the factory, 1181 McCarter Highway, Newark, N. J.

Allen B. Du Mont Labs., Inc. 2 Main Ave., Passaic, N. J.

Sun Radio Co. 212 Fulton St., New York, N. Y. Phono-&-Record Dept. has been added. Household electrical appliances carried in addition to straight radio.

Greyhound Equipment Co. 1270 Church Ave., Brooklyn, N. Y.

Capitol Radio Engineering Institute, 3224 Sixteenth St. N. W., Washington, D. C. New quarters contain offices, labs, shops, classrooms and dormitory for residence students. Home study courses continue.

(Continued on page 171)

APISH AMATEURS?



"If you monkey with your radio, you're an imbecillic ape!" hints this window-counter display, printed in 3 colors & gold. Supplemented by a streamer, similar to lower half of card, it's expected to discourage amateur tinkerers, encourage Servicemen's sales to sensible set owners, too wise to tinker.

THE LATEST RADIO EQUIPMENT

Manufacturers are invited to utilize these columns to bring improvements and new devices to the attention of technicians interested in every phase of Radio, Electronics and Public Address.



Home was never like this! (1664)



Portable sound system. (1670)

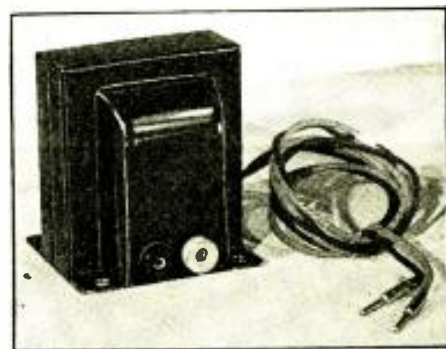

A 400-cycle output filter. (1671)

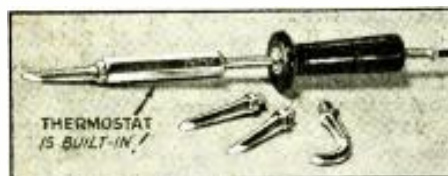

Outstanding improvement for radio men. (1665)

BEDLAMP RADIO SET (1664)

(Climax Radio and Television Co.)

UTILITY and entertainment are combined in the bedsteadhead combined lamp and A.C.-D.C. radio receiver here illustrated. The insert photo shows the underside of the instrument with the dial graduations arranged for convenient reading from a supine position. The reading light or radio receiver facilities of this honeymoon radio set are available separately or together.

GLASS-INSULATED WIRE (1667)

(Anaconda Wire & Cable Co.)

SPUN-GLASS insulation has been applied to many radio uses, as here illustrated. Magnet wire, sleeving, tape and lead wire are now available, all insulated with or composed of a spun-glass material called Vitrotex.

This material is an inorganic textile insulation manufactured from alkali-free glass for magnet wire, leads and coils. It is made of soft, lustrous fibers which are extremely flexible, and comparable to steel in tensile strength. Vitrotex-insulated magnet wires contain no other textile.

Advantages: it is fireproof; withstands high temperatures. Has high dielectric strength and insulation resistance. Is non-hygroscopic; unaffected by moisture. Possesses high resistance to acids, oils and corrosive vapors.

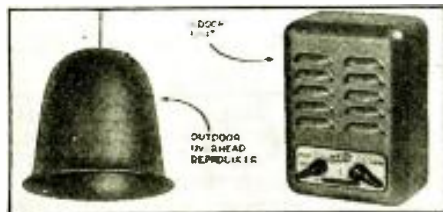

A good sideline item. (1666)

AUTOMATIC-HEAT SOLDERING IRON (1665)

(Vanatta Manufacturing Co.)

A THERMOSTAT built into the soldering iron here illustrated makes it possible to solder for hours on end without suffering the usual burned-up tips, burned-out heater, etc. The tool is said to be Underwriters Laboratory approved.

RADIO TESTING CLIP (1668)

(Mueller Electric Co.)

HERE is a clip which is claimed to be smaller than the smallest alligator clip on the market. It is perfectly adapted for test work in a crowded radio chassis or for making connection to a number of close-set terminals without shorting. Ideal for close-wound coils—the jaws will clear adjacent windings. Made of tough, spring-temper phosphor bronze; it will not heat up in high-frequency circuits because the hysteresis effect is absent.

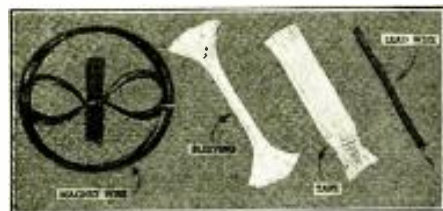

Spun-glass insulation is used! (1667)

WEATHERPROOF HOUSE-PHONE (1666)

(Setchell Carlson, Inc.)

THERE are several features which recommended this new home or office interphone as a sideline item for Servicemen. The remote loudspeaker is weatherproof and hence may be mounted outdoors, as for instance over rear and front doors of a home. The indoor unit combines an amplifier which utilizes two 19's and a 33, switching facilities, and a second loudspeaker. Each loudspeaker works optionally as a microphone. Note that, unlike most A.C.-operated interphones, this new unit uses direct-heater tubes and consequently need be turned on only when in actual use; just flip the switch to ON . . . and talk!

INDUSTRIAL-TYPE SOCKET (1668A)

(Hammarlund Mfg. Co.)

STRUCTURAL features recommend the new Hammarlund wafer socket for use wherever ruggedness is required. Socket is of bakelized canvas; contacts are of heavy, non-corrosive, reinforced metal. Unit is designed especially for use in sound equipment and other apparatus where a great many tube changes ordinarily cause socket failure. (This item is not illustrated.—Editor)

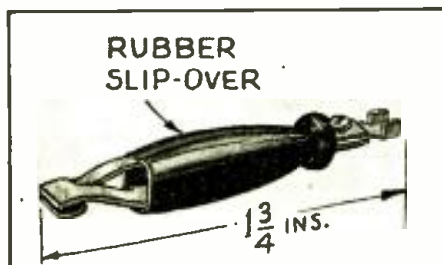

Clips, special for radio use. (1668)

SIDE-CONTROLLED RECEIVER—NOVELTY IN NEW SET LINE (1669)

(RCA Victor Division, RCA Mfg. Co., Inc.)

THIS model 9X receiver is a 4-tube midget for A.C.-D.C. operation. The modern, compact cabinet has controls conveniently placed on the side for easy operation.

It has built-in antenna, metal tubes, illuminated easy-reading drum-type dial, (Continued on page 178)

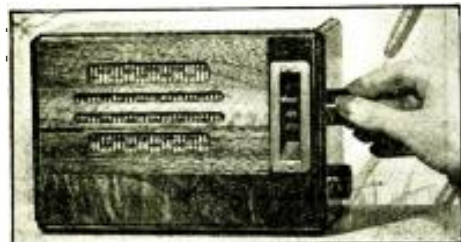

Side-controlled midget receiver. (1669)

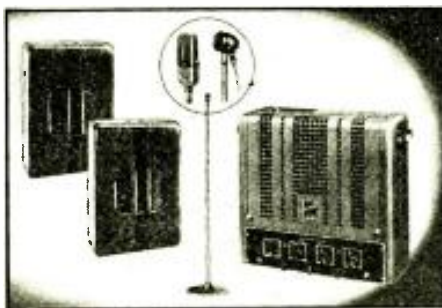

A 60-W. sound system. (1672)

Name and address of any manufacturer will be sent on receipt of self-addressed, stamped envelope. Kindly give (number) in above description of device.

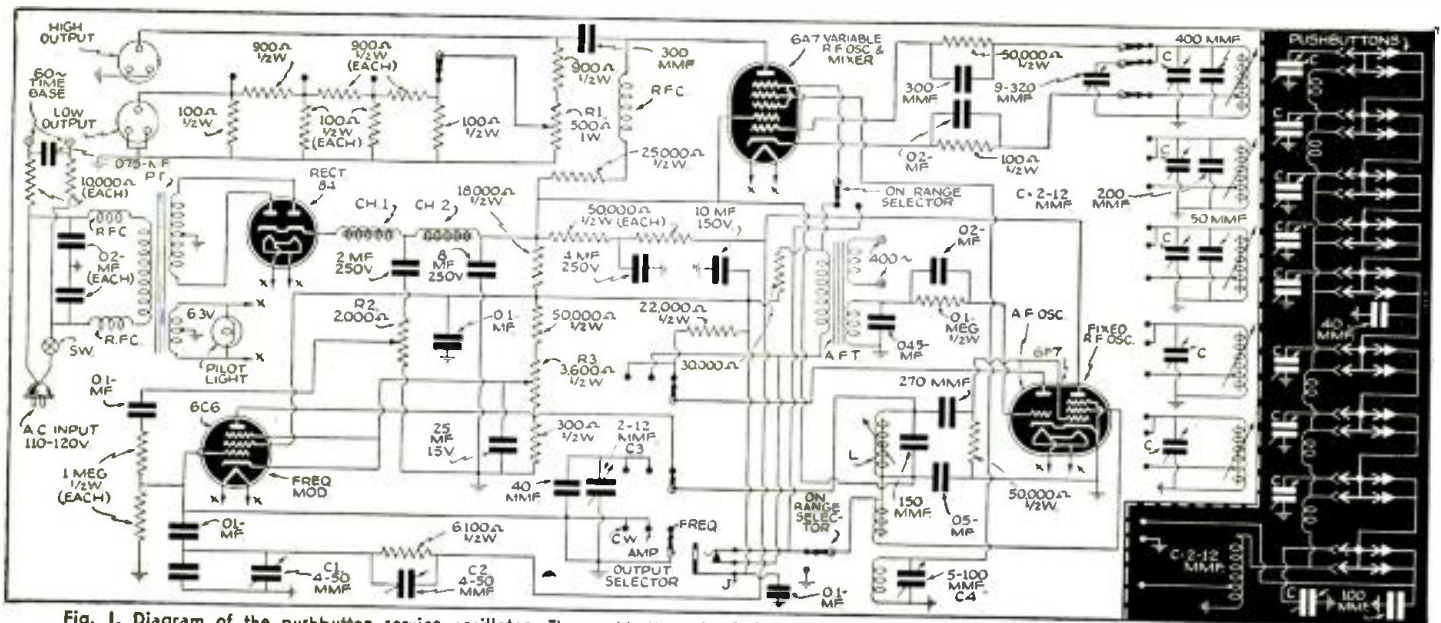

Fig. 1. Diagram of the pushbutton service oscillator. The pushbutton circuit is in the black area; the frequency modulator, inside the dotted lines.

PUSHBUTTON SIGNAL GENERATOR

Instantaneous selection of test frequencies greatly speeds servicing—where time is money! "Pushbutton" I.F., R.F. and A.V.C. alignment is described.

SAMUEL C. MILBOURNE

THIS fall will see a widening of the pushbutton influence in not only radio receivers but other radio equipment, notably service test instruments.

And, why not? Pushbuttons are easier and quicker to operate than rotary switches and, therefore, save time. Time is money to a Serviceman, hence their practical application. If you desire to change a rotary switch from No. 1 to No. 5 position, it is necessary to rotate through No. 2, No. 3 and No. 4 positions. A pushbutton unit requires only a push on the No. 5 button which simultaneously locks it in place and releases the previously-pushed button.

What test instruments are best adapted for pushbutton operation? How will we do this?

First, the writer believes that the *signal generator* is among the vanguard of test instruments which can profitably be pushbutton tuned. This may take the form of a straight pushbutton job with a number of fixed frequencies, or it may be a combination pushbutton-manual type.

9 BUTTONS FOR 91.5% OF ALL I.F.'S

An illustration of this second type may be noted in Fig. A. Here is an R.F. signal generator with a manually-tuned dial and, in addition, 9 pushbuttons which control individually-tuned I.F. and R.F. fixed-frequency circuits. Five intermediate frequencies (175, 262.5, 456, 460 and 465 kc.) and 4 radio frequencies (600, 1,000, 1,400 and 1,600 kc.) are available. These frequencies have been carefully picked after a comprehensive survey of all the receivers which were ever built, *91.5% of which are alignable by utilizing the above fixed frequencies!*

In Fig. 1, the complete diagram of

the pushbutton signal generator, fixed-tuned circuit which utilizes special air-dielectric trimmers, is set off by a black background. The main dial tuning circuits incorporate iron-tuned inductances and air-dielectric trimmers so that *both* ends of the signal generator dial may be brought into line. This, it is felt, will mark a major step forward in the stability and accuracy of signal generator design.

Both the fixed-frequency circuits and the main tuning dial circuits are so arranged that no matter what type of output signal is desired, it can be readily obtained at the *same point* on the dial (or on the same pushbutton) without recourse to addition or subtraction.

Another feature of this model is the completely electronic frequency-modulator which is used for visual alignment work. Its circuit is shown in Fig. 1 which illustrates the complete circuit of the oscillator. This is the only visual alignment circuit which automatically locks, centers and synchronizes the image without using external means. It eliminates image wandering and "jiggling."

"PUSHBUTTON" I.F. ALIGNMENT

The operation of the pushbutton-type signal generator for alignment work is even easier than the explanation. Refer to Fig. 2. Here we have a standard superhet. drawn in block diagram form.

First, we connect the vertical plates of our oscilloscope across the 2nd-detector diode load resistor (or as recommended by the receiver's manufacturer). Next, we note that the set's I.F. is 456 kc. and push the 456 kc. button on the signal generator, adjust

(Continued on next page)



Fig. A. The model 582A signal generator.

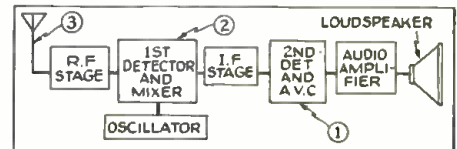

Fig. 2 Block diagram of a typical superhet. set

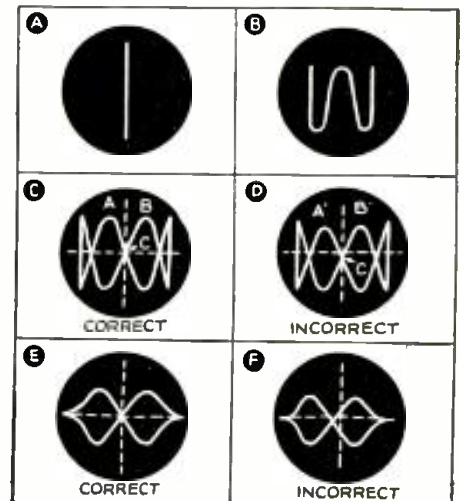

Fig. 3. Oscilloscope curves for set alignment.

PUSHBUTTON SIGNAL GENERATOR

(Continued from preceding page)

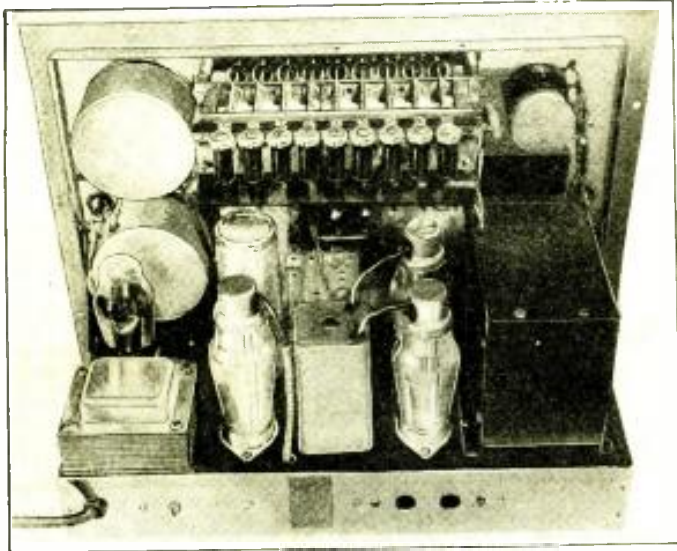

Fig. B

Outstanding advantage of pushbutton control of the service oscillator or "signal generator" is the speed with which precise test frequencies may be set up on the instrument. Its rear view shows the neat assembly, with pushbutton unit at top.

ing it for amplitude modulation and connecting its output between grid of the 1st-detector tube and chassis, removing the tube's grid cap temporarily. If the oscillator circuit interferes, we temporarily remove the tube (if separate tube) or short across the oscillator section of the tuning condenser gang. Sets employing A.F.C., noise suppression circuits, A.V.C., etc., should be suitably prepared before any type of alignment is started.

Starting at the I.F. trimmer next to the 2nd-detector tube, we work back toward the 1st-detector, adjusting each stage for maximum gain which will be shown on the 'scope's screen as an ever increasing vertical line. (See Fig. 3A.) Care should be exercised in keeping the 'scope circuit wide open and adjusting the signal generator's output until a reasonable length line is shown on the 'scope's screen. This will not trigger the A.V.C. (or the A.V.C. may be disconnected if desired).

After aligning the I.F. stages for maximum mean frequency acceptance, we flip over to Frequency Modulation (using the same pushbutton) and, after connecting the horizontal plate circuits of the 'scope to the Time Base on the signal generator, adjust the I.F. trimmers to the proper acceptability curve such as shown in Fig. 3B. This completes the I.F. alignment.

"PUSHBUTTON" R.F. ALIGNMENT

Next, we align the R.F. and oscillator stages at 1,400 kc. by pushing the 1,400 kc. button (which releases the 456 kc. button). We connect the signal generator to the antenna and ground posts of the receiver through about a 600-ohm resistor and disconnect the Time Base from the 'scope, flipping the signal generator's switch back to Amplitude Modulation. The receiver should also be turned to 1,400 kc. Adjustment of the R.F. and oscillator trimmers is made until the greatest amplitude of the line is shown on the screen (see Fig. 3A). Then, leaving everything as it is, push the 600 kc. button on the signal generator and retune the set to 600 kc. This time, adjust the oscillator padder condenser. Then, flip to Frequency Modulation and finish the job at 600 kc.

That's all there is to it. Snappy, efficient alignment and when you have to come back to the same frequency for a recheck, you know it is the same frequency and you do not have to depend upon setting the dial at exactly the same place both times.

"PUSHBUTTON" A.F.C. ALIGNMENT

Another very interesting feature of this instrument is the automatic adjustment of the A.F.C. circuits. This is an adjustment which follows naturally after visual alignment of the I.F. stages. The signal generator is connected to the control-grid of the 1st-detector with all controls set for normal visual alignment. The vertical amplifier of this 'scope is connected between the ungrounded cathode of the discriminator diode and chassis. The special time base on the signal generator should be connected to the 'scope's horizontal circuits during this test.

After first backing out the secondary trimming condenser, adjust the primary trimmer so that the height of the image on the 'scope screen will be maximum. You will have an image like Fig. 3D. Then, adjust the secondary trimmer until the "crossover" or crossing point marked C is on a line with the centerline of the image. Correct adjustment is shown in Fig. 3C. After readjusting each trimmer once more for maximum height and correct image, the job is finished in a third the time necessary for any other system!

Once you have adjusted sets by this method, you will see how labor-saving it is. Study Figs. 3C and 3D again. Note that loops A and B are identical and that correct adjustment is reached when C is exactly on the centerline. When an incorrect adjustment is made, the 2 loops A and B, in Fig. 3C, merely move apart to positions A1 and B1 in Fig. 3D. The correct adjustment is easy and the degree of mis-adjustment is always known exactly.

However, this is not the case with other methods as the 2 loops are not necessarily the same due to either (1) non-linear sawtooth sweep or (2) methods of wobulation in the signal generator. This is illustrated by Figs. 3E and 3F. The only thing you have to go by is the position of the crossing point, which just drifts up and down, sideways and at times even moves entirely off the screen. Due to these effects and also to the fact that the 2 loops are seldom the same in size and shape, other methods are time wasting and sometimes gravely erroneous.

However, with the signal generator's (a model No. 582A, incidentally) triple-interlocking A.F.C. adjustment circuit, correct A.F.C. alignment is automatically assured and, in combination with pushbutton sig-

nal generator tuning, brings to the Serviceman a completely new approach to service profits.

FUNCTIONS OF COMPONENTS

The following additional information covers the functions of the controls and components not otherwise described in the text.

R₁—Attenuator control used in conjunction with ladder multiplier unit for varying output of the oscillator.

R₂—Control for varying the frequency modulation band, its adjustment gives a variation in band sweep from 0 to 40 kc.

R₃—Bias adjustment on the frequency control tube (6C6) by which the frequency modulation band is made symmetrical with respect to the frequency of the fixed oscillator.

C₁ & C₂—Adjustments of the phase and amount of R.F. voltage fed into the 6C6's grid whereby a 40 kc. sweep is obtained.

C₃—Compensation condenser to retune fixed oscillator after the frequency control tube is removed from the oscillating circuit.

C₄—Tunes trap circuit to the frequency of the fixed oscillator.

J—Modulation jack whereby any audio oscillator may be used to modulate R.F. signal.

L—Permeability-tuned fixed oscillator coil through which the plate of the frequency control tube is energized.

SERVICES OF THE TUBES

The power supply contains a type 84 full-wave rectifier whose filter system is a choke input. This is used so that a sine-wave, 120-cycle signal may be had for the control-grid of the frequency control tube, a type 6C6. When frequency modulation is desired, the 6C6 is switched across the grid coil of the pentode section of a type 6F7, which oscillates at a fixed frequency of 850 kc. This is heterodyned with a variable oscillator, a type 6A7 and the output calibrated in the difference of the two signals.

When an audio modulated signal is desired, the 6C6 is removed from the circuit and the triode section of the 6F7 oscillates at 400 cycles. This signal is placed in series with the plate of the pentode section of the 6F7, which beats with the 6A7. This is true of signals on the first 3 bands, and at this point the fixed oscillator is thrown out of the circuit; the 400-cycle signal being injected into the screen-grid of the 6A7.

All fixed condensers in the oscillator circuit are silver caps, and all variable air trimmers. The coils are permeability-tuned.

Pushbutton assembly. When the range selector is in the Automatic position, the tuning condenser is out of the circuit and each frequency has an individual air trimmer. Such a large frequency coverage on one coil is made possible by the use of a series-type pushbutton switch.

This article has been prepared from data supplied by courtesy of Supreme Instruments Corporation.

"Combined Hearing-Aid and Interphone"—A correction

In the article under this title, in the August, 1938 issue of Radio-Craft, pgs. 92, 93, etc., the first tube in the circuit is repeatedly referred to in the text as a 12A7, whereas, the diagrams show it as a 6B8G. Experiments showed that better results would be secured if the 12A7 used in the original set up was replaced (as corrected in the diagrams) by the 6B8G.

USEFUL CIRCUIT IDEAS

Three cash prizes are awarded for the most useful circuit ideas published in this department. They are: 1st Prize \$10, 2nd Prize \$5, 3rd Prize \$5. All others judged good, and published, are given Honorable Mention.

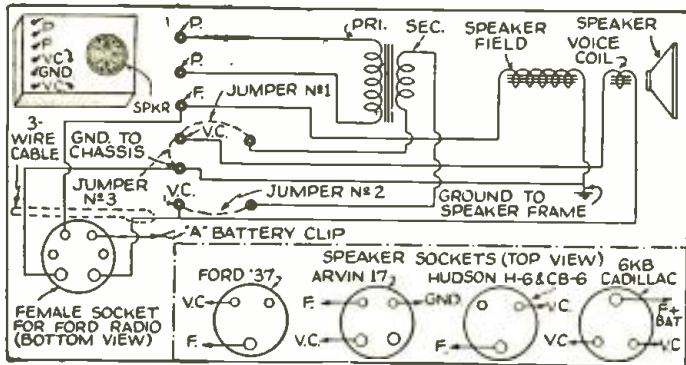

Fig. 1. Universal test speaker.

FIRST PRIZE—\$10

A UNIVERSAL TEST SPEAKER. I find this idea useful for auto-radio work. It eliminates the removal of overhead or separate speaker from the car. The diagram is self-explanatory. (See Fig. 1.)

The jumpers indicated are equipped with phone tips.

Several 24-in. leads are made up using phone tips on one end and a large or small tube prong on the other to connect speaker to radio set.

Most speaker sockets have large and small holes.

The cable-and-plug shown is used for the '35 and '36 Ford radios. These models predominate in this locality and I use this arrangement to speed up connections.

The long lead with clip is used on the models having the "A" lead connected to speaker plug.

The speaker is a 6-in. auto-radio model with output transformer and is housed in a wooden case, 12 x 8 x 6 ins. wide. The back cover is hinged and all cables, leads and diagrams of speaker sockets are kept inside.

The jacks shown on diagram are mounted in the top of the box at one end. In all cases a lead must be connected between jack marked Gnd. and radio chassis or case.

Servicemen must judge for themselves whether their car-radio service work is sufficient to warrant making this unit.

R. R. SMITH

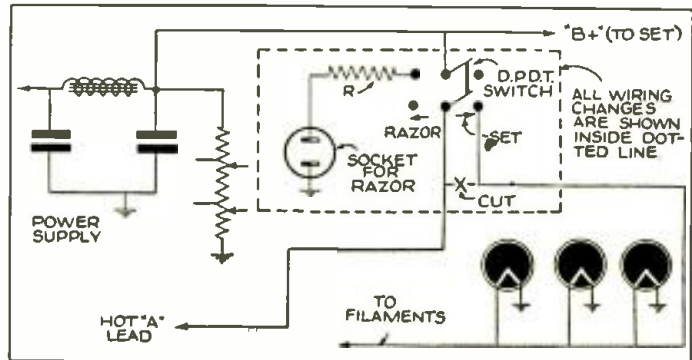

Fig. 2. A 6-volt supply for dry shaver.

SECOND PRIZE—\$5

OPERATING AN ELECTRIC RAZOR FROM AN AUTO-RADIO SET. Many people who possess 110-volt "dry shavers" would like to be able to use them on camping trips when 110-volt electricity is not available. As these electric razors operate on either A.C. or D.C. and draw only very little current, they can be run from the power supply of an auto-radio set and may be easily connected as shown in the diagram, Fig. 2. The switch disconnects the filaments of all the tubes except the rectifier (if any), thus relieving the power supply of the plate current. The resistance, R, must be of the correct value to reduce the voltage delivered by the power supply to approximately 110 volts when the razor is running. This value must be found by experimentation.

*Mine is a Schick Dry Shaver.

G. E. WENIGER

a 45-volt "B" battery of the cheaper sort and get the additional drop from a power rheostat in the plate supply. Thus with a milliammeter in the "B" lead I can adjust the plate current to 35 ma. I have this on one of my P.A. rigs and on jobs that don't require more than 12 watts I just put a jumper across the tip-jacks that take the 45-volt "C" battery and get all my bias from the rheostat. In class A prime operation with battery bias, grid current has a tendency to charge up the battery and increase its voltage, but with this circuit the operator can control this with the supplementary bias from the rheostat.

ROBERT F. WALLACE

HONORABLE MENTION

A KINK FOR USING OLD TUNING EYE TUBES that no longer can be used as indicators but in which the triode section still checks OK. Most Servicemen have a few such tubes in their shops. Types 6E5, 6G5, 6T5 and 6U5 are more common.

These tubes can be used as audio amplifiers with quite a bit of gain. The circuit in Fig. 4A is an example. The target should be grounded when not used.

Another example, Fig. 4B, is for using the tube as a 2nd-detector in a superhet. In this case the target is used as a diode. This works almost as well as a type 75 tube.

ROLAND T. SCHAEFER

(Continued on next page)

THIRD PRIZE—\$5

SEMI-FIXED-BIAS. The tube manual data state that the 45-type tube is capable of 12 watts output when self-biased and 18 watts with fixed-bias in push-pull. To get the extra 6 watts it is necessary to provide an extra rectifier tube and filter system or else to use a battery. (See Fig. 3.) Since there is no convenient 68-volt battery I use

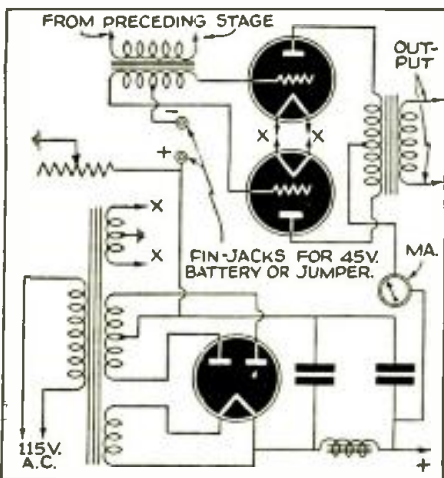

Fig. 3. 18 watts with fixed-bias.

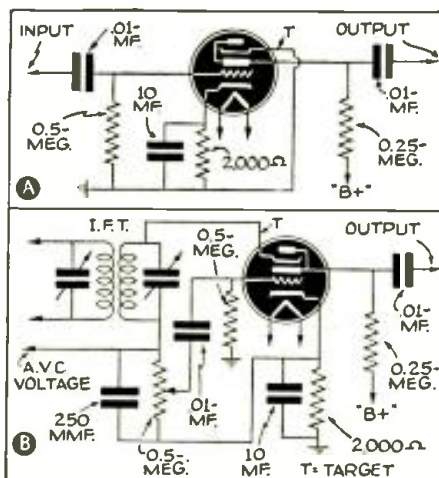

Fig. 4. New use for old tuning eye.

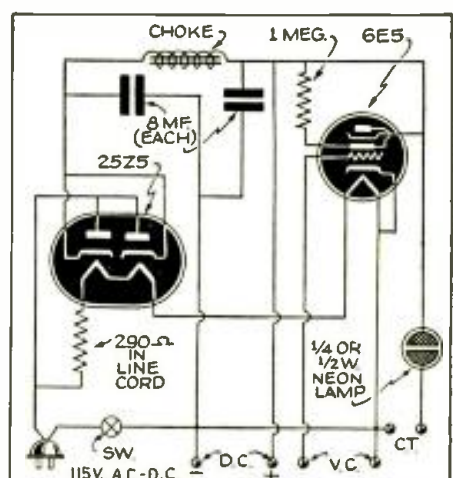

Fig. 5. Versatile tester and power supply.

USEFUL CIRCUIT IDEAS

(Continued from preceding page)

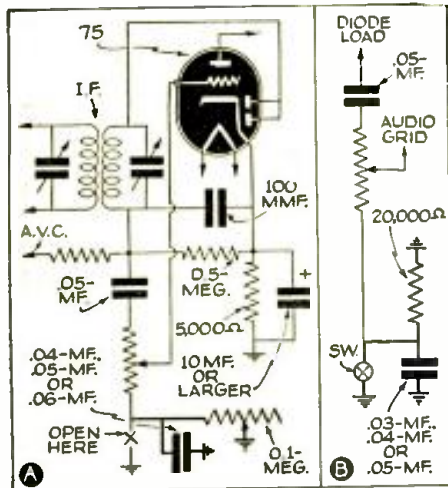

Fig. 6. Modified bass-compensation method.

HONORABLE MENTION

INEXPENSIVE, VISUAL OUTPUT INDICATOR, NEON CONDENSER TESTER AND 100 TO 150 D.C. POWER SUPPLY. Since constructing the piece of equipment diagrammed in Fig. 5, I have found it very handy on the test bench.

Points marked - + D.C. are for the power supply which I have successfully substituted for "B" batteries when servicing battery sets. Different voltages may be

obtained by using a tapped voltage divider (not shown).

The 6E5 makes a splendid output indicator by connecting points V.C. to the output transformer in place of, or across, the voice coil.

Points C.T. are to be used for the usual neon condenser test. Note that the filaments of the 25Z5 and 6E5 are connected in series with a 290-ohm line cord resistor.

C. R. PRESTON

HONORABLE MENTION

A MODIFIED BASS-COMPENSATION METHOD. Here is a simple system for adding real controllable bass boosting to old receivers or phono amplifiers. With this method the bass boosting can be used or cut out as desired without upsetting the normal operation of the set. No alterations need be made to the set, at all, except the opening up of the grounded side of the audio volume control.

In Fig. 6A you will find the connections as made to a standard diode detector circuit of a 75 or similar tube. The added apparatus and connections are shown in heavy lines. The value of the bass compensation condenser, for best results, will be one of the 3 noted, depending on the degree of signal voltage maintained across the diode load by the A.V.C. system. A receiver set to high sensitivity so that a strong signal is introduced into the 2nd-detector gives best results. The bass

booster volume control could be of a different total value but one of 0.1-meg., as noted, tapered for tone control service gives fine results.

In using the control, it is best to rotate it all the way to the signal-end which grounds the normal ground-end of the regular volume control, then advance the regular volume to the desired high-note response. When this is done the bass control can be rotated to give the desired amount of bass boosting. If the proper size compensation condenser has been selected there will be an increase in the bass response without any change in the high- and middle-response level already selected.

One might say that this is simply a bass compensation method without using the tapped volume control, which it is, except the results are entirely different. The tapped control is designed primarily for an automatic tone control when "playing" the outfit at low volume, while this method is for increased bass response at loud and normal volume levels. The writer has used all types and sizes of tapped controls and favors them for their particular service but to illustrate the value of the variable tap method as outlined above, has changed to it on newly constructed receivers, and without using the tap which was on the regular volume control.

The writer has also applied this system to several automobile receivers except that instead of the variable control a fixed resistor of 20,000 ohms was used, as shown in Fig. 6B. The switch for cutting the bass in and out was mounted on the cabinet of the receiver like the regular tone control of some jobs.

HUGH N. MONTGOMERY

40-WATT PHONE—C. W. TRANSMITTER FOR 5-, 10-, AND 20-METER BANDS

(Continued from page 147)

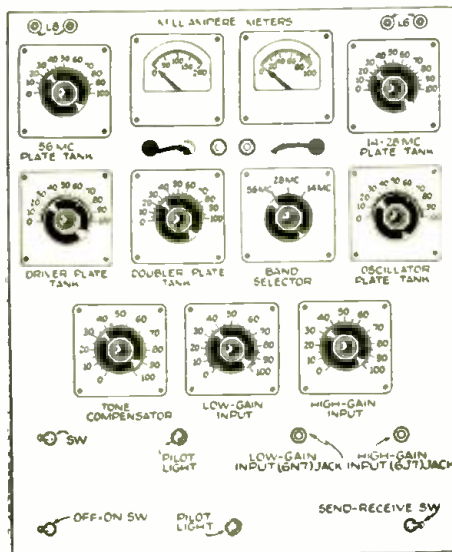

Front-panel controls and markings.

signal, and one entirely stable. (The entire unit is available in kit form.)

LIST OF PARTS

One carbon resistor, 50,000 ohms, 2 W., R1;
One Utah vitreous resistor, CC-250, 250 ohms, 10 W., R2;
One Utah vitreous resistor, CC-20-M, 20,000 ohms, 10 W., R3;

One Utah vitreous resistor, CC-10-M, 10,000 ohms, 10 W., R4;
One Utah resistor, 50-A, with 2 adj. lugs, 25,000 ohms, 50 W., R5;
One Utah vitreous resistor, EE30M, 30,000 ohms, 20 W., R6;
One carbon resistor, 2 megs., 1/4-W., R7;
One carbon resistor, 3,500 ohms, 1 W., R8;
One carbon resistor, 1 meg., 1 W., R9;
One carbon resistor, 0.25-meg., 1 W., R10;
One carbon resistor, 50,000 ohms, 1 W., R11;
One Utah potentiometer, RCP500M, 0.5-meg., R12;
One carbon resistor, 2,000 ohms, 1 W., R13;
One carbon resistor, 50,000 ohms, 1 W., R14;
One carbon resistor, 10,000 ohms, 1 W., R15;
One carbon resistor, 0.5-meg., 1 W., R16;
One carbon resistor, 1,500 ohms, 1 W., R17;
One Utah vitreous resistor, CC10M, 10,000 ohms, 10 W., R18;
One Utah vitreous resistor, CC200, 200 ohms, 10 W., R19;
One Utah resistor, 50-A, 60,000 ohms, 50 W. tapped at 2,800 ohms, R20;
One Utah vitreous resistor, KK50M, 50,000 ohms, 20 W., R21;
One Utah potentiometer, RCP100M, 0.1-meg., R22;
One mica condenser, 105 mmf., 600 V., C1;
One mica condenser, 0.01-mf., 1,000 V., C2;
One mica condenser, 0.001-mf., 1,000 V., C3;
One paper condenser, 0.1-mf., 600 V., C4;
One mica condenser, 100 mmf., 1,000 V., C5;
One mica condenser, 250 mmf., 1,000 V., C6;
One National condenser, ST150, 150 mmf., C7;
One National condenser, ST35, 35 mmf., C8;
One National condenser, ST150, 150 mmf., C9;
One National condenser, STD35, 35-35 mmf., C10;
One cartridge type neutralizing condenser, C11;
One paper condenser, 0.1-mf., 400 V., C12;
One electrolytic condenser, 2 mf., 450 V., C13;
One electrolytic condenser, 10 mf., 25 V., C14;
One electrolytic condenser, 10 mf., 75 V., C15;
One paper condenser, 0.02-mf., 600 V., C16;
One electrolytic condenser, 8 mf., 450 V., C17;
One oil-filled condenser, 4 mf., 600 V., C18;
One National condenser, ST20, 20 mmf., C19;
One Utah input transformer, No. 8425, T1;
One Utah output transformer, No. 8636, T2;
One Utah plate and filament transformer, No. 2404, T3;
One Utah filament transformer, No. 2405, T4;
One Utah plate transformer, No. 2406, T5;
One Utah input choke, No. 4781, T6;
One Utah filter choke, No. 4769, T7;
One Utah choke, No. 4782, T8;
One Utah special band-changing switch.

This article has been prepared from data supplied by courtesy of Utah Radio Products Co.

WAR GAME!

(Continued from page 137)

storms struck North America and played hob with radio transmission in certain sections but though generated voltages in land lines ranged from 500 to 1,000 V., protective devices prevented interference with the operation of the teletypewriters.

Although this war ranged from one end of the Atlantic coast to the other, day and night for about a week, the final and climatic event was the test "blockout".

Farmingdale, Long Island, blackened against the threatened air attack of the hypothetical invading force, served in the dual role of demonstrating the extreme utility of radio's broadcasting network as a defense agent in the event of an invasion; and of providing thrilling entertainment to the millions of listeners who heard ace narrators of the networks describe the air-raid maneuvers.

3 BROADCASTS

Both C.B.S. and N.B.C. broadcast announcers and technicians cooperated in bringing to listeners via their respective networks the entertainment and protective phases of the Farmingdale blackout. The first broadcast brought to the microphone Major General Frank M. Andrews, the commanding general of the G.H.Q. Air Force, and Brigadier General Frederick L. Martin, in charge of pursuit force operations. These Army aviation leaders explained to listeners what the maneuvers were expected to accomplish.

The second broadcast, 4 days later, brought the exciting details of the bombardment of Farmingdale, with both defense and attack strategies realistically simulated by members of the Army Air Corps. At the same time the network program was utilized as part of the defense measures when Mayor Frank Scholl of Farmingdale instructed citizens to remain tuned to the networks to receive instructions that he and officers of the "defending" army broadcast for their "protection" in the realistically simulated air-raid.

The concluding broadcast, the next day, again brought to the microphones Generals Andrews, Emmons, Krogstad and Martin, who reviewed the entire fleet of more than 200 bombers and told what they believed the maneuvers had accomplished for the national defense.

BLACKOUT

During the night raid on Farmingdale a battery of C.B.S. announcers reported the raid from strategic points. From one of the "Flying Fortress" bombers, John Reed King gave a graphic, air-view account of the attack. From defense headquarters, Bob Trout gave a colorful description of the progress of the battle as it was being directed by Brigadier General Frederick L. Martin, chief of defense operations in the war games, from headquarters at Seversky Field. For man-in-the-street reactions, Charles Stark was stationed at the Farmingdale firehouse to conduct interviews with citizens. The sounds of the pursuit, and attacking and bombing airplanes, and the commands of the attacking and defending officers were heard.

This broadcast of the attack on Farmingdale was short-waved over Columbia's station W2XE to South America. As the event took place at an inopportune time for European shortwave points, a record of the events was preserved and short-waved to Europe the following day!

The National Broadcasting Company was on hand with a crew of engineers, an-

nouncers, and portable equipment, to give, not only eye-witness accounts of these maneuvers, but also to play an important part in the actual maneuvers themselves.

N.B.C.'s activity began with the first phase of the maneuvers, when an N.B.C. civilian observer accompanied the flight of 3 XB-15 Army bombers from Mitchel Field to a destination and a mission which was unrevealed at the time of the take-off. Permission was previously obtained by the National Broadcasting Company to send this civilian observer along on the flight so that American radio listeners might hear a first-hand account of the Army Air Force in action. This first flight maneuver was undertaken to test the efficiency and the readiness of the Army Air Force in the defense of the country against any possible aggressor. The broadcast began when the planes were 610 miles North-East of Ambrose Light off the New York coast. The flight was undertaken on the assumption that the fleet of a European power, a member of the coalition, was escorting troop transports, and the Army's assumed information was sufficient to indicate that this force intended to make a landing somewhere in the New England area. During the course of the flight, the Army air squadrons sighted the liner *Rex* 3 days out of New York and an exchange of greetings between the N.B.C. announcer and the Captain of the Italian liner, was broadcast to listeners over the N.B.C. networks.

During the air raid drill 4 days later—in which the 36th Pursuit squadron and the 62nd Coast Guard artillery anti-aircraft regiment defended the important aircraft batteries at Farmingdale, Long Island, against the raid by a formation of enemy bombers—the National Broadcasting Company carried this maneuver to the network from 4 distinct broadcasting positions. Announcer George Hicks was at headquarters, Announcers Hurluf, Provensen and Gene Hamilton were aboard the N.B.C. Mobile Unit in the town of Farmingdale, Announcer Edward Herlihy, equipped with a pack set, was on the roof of an airplane hangar in the town, while Announcer Daniel Russell, also equipped with a pack set, broadcast observations from anti-aircraft positions. In a pre-arranged broadcast an hour before the bombing, the N.B.C., simultaneously with C.B.S., carried the warning to residents of Farmingdale by Mayor Frank Scholl of that town, asking them to cooperate with the War Department in turning off all lights during the maneuvers.

Mutual Broadcasting System was represented during two broadcasts. In the blackout pick-up, Tom Slater graphically recounted developments outside the Seversky airplane factory, actual objective of the raid. Flying alongside the XB-15 bomber in which was the C.B.S. crew, was Dave Driscoll of M.B.S. in another XB-15 flying at an altitude of about 8,000 ft. in reconnaissance service. Other XB-15 Flying Fortresses were overhead at 15,000 ft. altitude in actual bombing flight.

This was the first example of direct radio participation in Army air maneuvers.

(The writer concludes with a word of appreciation not only to the several companies mentioned in this article, for their cooperation in supplying reference material and illustrations, but also to George G. Breed, Long Lines Dept., American Tel. & Tel. Co., for photographs, and permission to quote from his article in the house organ, *Telephone Review*.)

FREE-Allied's
1939 RADIO
CATALOG
180 PAGES! JUST OUT!

EVERYTHING IN RADIO
at Lowest Prices!

NEW SETS!
82 amazing 1939 KNIGHT Radios—as low as \$7.95! 4-16 tubes—new "Toony-Weenys," low-drain battery sets (1.5 tubes), record players, phonographs, photo-radios!

NEW SOUND!
Complete range of new P.A.—6-65 watts, New Portable systems, 30 watt Mobile System, Booster Power S.i.g.e. Electric Guitar Amplifier,—and a complete line of recording equipment.

NEW PARTS—KITS!
More than 14,000 parts! New Build-Your-Own kits: Beginners' 1, 2, and 3 tubes, 6 tube auto radio, Photo Coll. Electric Fence, 4 Tube Portable, low-cost transmitters, etc.—and diagrams and projects for building 100 kits!

NEW HAM GEAR!
A new Giant Ham section! New Hatteraters ship-to-shore, National, Ham-mariund, Utah, and GTC X-mitters as low as \$15.95; new receivers: National NC-510 and NC-44; Hallcrafters "Dual Diversity" and "Marine" and "Sargent" and "Streamliner"; Howard, etc.

NEW TESTERS!
All leading lines! New Push-Button type equipment, Rider's Chanalysm—Tube Checkers, Set Testers, Analyzers, Oscillographs, Meters—and over 14,000 parts!



Fastest Service, Highest Quality, Lowest Prices! Write for ALLIED's new 1939 Catalog!

Free!
SEND COUPON

Allied Radio Corporation,
Dept. 2-J-9,
833 W. Jackson Blvd.,
Chicago, Ill.
Send me your new FREE 1939 catalogue.

Name

Address

City State

ALLIED RADIO CORP.

Please Say That You Saw It in RADIO-CRAFT

WHEN TELEVISION COMES AROUND! . . .

(Continued from page 149)

Only 22¢ a Day

Puts This All-Purpose ELECTRIC ARC WELDER IN YOUR SHOP

TEN DAY TRIAL

GUARANTEED

TEN MONTHS TO DAY

STOP THROWING AWAY PROFITS! DO YOUR OWN WELDING!

That's the modern way to increase income and customer satisfaction. And it takes only 22¢ a day to do it. Yes, you get the sensational profession. All details FREE

PURPOSE. Commonwealth Arc Welder—Model 120-FS for only \$3.75 down, with ten whole months to pay balance out of profits. Now, for the first time, it is EASY for every inventor, laboratory, home workshop owner, garage, repair shop, and factory to afford a complete welding service in manufacturing, maintenance, experimental or repair work.

Works on 110 or 220-Volt A.C.
Simply plug into a 110 or 220-volt, 60-cycle A.C. line. Economical—costs only a few pennies an hour to operate. Often pays for itself on first or second job. Portable—can be carried right to outside jobs in auto, truck or side car. Anyone can weld with its easy striking, automatically-stabilized arc. Comes complete with helmet, electrode holder, welding rods, etc. Nothing else to buy. Fully Guaranteed. Breath-taking low price! Saves and makes hundreds of dollars.



Handles ALL Welding—Sheet Metal to Heavy Castings
Model 120-FS is a big, 110-pound, man-sized, heavy-duty welder with efficiency of machines costing many dollars more. Welds iron, steel, cast iron, cast steel, and alloys of them. Size heats and everything from fenders and light sheet metal to motor blocks and heavy castings. Also fine for soldering and brazing. Uses standard welding rods. No experience or special training needed to operate. Simple complete instructions for doing all kinds welding jobs included. MAIL COUPON BELOW for complete FREE details. COMMONWEALTH MFG. CORP., Dept. Y-71, Cincinnati, Ohio.

MAIL COUPON FOR DETAILS GET 22¢ A DAY PLAN

Commonwealth Mfg. Corp., Dept. Y-71, 4208 Davis Lane, Cincinnati, Ohio, all details please rush me at once. I wish to know about Model 120-FS Electric Arc Welder with Deluxe Accessories, and your 22¢-a-day plan.

Name

Address

Town

State

FORMULAS AND RECIPES

For the Practical Man

Here Is the Contents of the Book

1. Adhesives; Glues; Cements; Gums; Mucilages.
2. Lubricants; 3. Cleansing; Stain Removers; Paint Removers; Bleaches; Cleaning Fluids; 3. Metal Craft; Coloring; Oxidizing; Plating; Repairing; Welding; Polishes; Alloys; Solders; Amalgams.
4. Paints; Colors; Stains; Varnishes; Enamels; Luminous Paint; Washable Paint; Paint-Remover; Waterproofing; Fireproofing; 5. Glass-Working; Cutting; Drilling; Boring; Bending; Blowing; Etching; Engraving; Frosting; Silver-ink, etc.
6. Wood-craft; Fillers; Fireproofing; Acid-proofing; Waterproofing; Furniture Polishes; Finishes, etc.
7. Inks; Recipes; Eradicators; Ink Stain Removers; Special Inks; Colored; Indelible; Sympathetic; Invisible; Hectograph
8. Photography; Developers; Emulsions; Fixers; Sensitizing; Toning; Printing; Photographic Paper; Blueprint Paper; 9. Antidotes for Poisons; Remedies for Burns and Scalds; Disinfectants; First-Aid in Accidents; Emergency Remedies; Home Remedies; 10. Preparation; Manipulation; Handling; Mixing; Measuring; Weighing; Filtering; Straining; Solutions; List of Technical Substances; Emulsifying; Use of Hydrometer; Use of Thermometer; Tables of Weights and Measures; Decimal Systems; Useful Tables.

PRICE 50¢ POSTPAID

Send check, cash, money order or stamps.

TECHNIFAX

Division RC-938
558 W. WASHINGTON BLVD. CHICAGO, ILL.

during the televised program between, say, 4 different studios with certainly (again economics reign) no more than 2 camera angles (long and close) in each studio. That would net them a grand total of 8 possible changes or cuts or angles. Contrast that with the average motion picture which would in the same hour project a hundred or more cuts from one to another angle of the many, many scenes, not merely 8 changes.

Compare the above to the average 3 to 500,000 feet of film the movie director and editor have at their disposal when they sit down to eliminate the poorer performances and select, at will, the most effective 7 or 8,000 feet of all that exposed film. One hour of movie entertainment may have taken a month or more to shoot. Remember too that in the radio studio no member of the cast, in any of the 8 angles or cuts, dare utter a sour note or word; for, once that unpardonable is radiated, it cannot be retracted. Whereas movie errors can be cut out and better performances spliced in. Is not the comparison rather brutal?

The answer is simple. If we want the equivalent of a Hollywood production to be televised, we need but work out a new technique beginning with the script itself. Thinking in terms of a small screen, and plugging for simplicity and effectiveness all along the line, we can MAKE MOVIES ESPECIALLY FOR TELEVISION.

Then, if land-wire costs be prohibitive duplicate prints of the same material might be shipped to all metropolitan points of radiation. By such a procedure problems of synchronization between cities would be eliminated and (a great gain for the sponsors) differences between time belts could be ignored. New York could radiate at a chosen time of the day and San Francisco could transmit the identical program 3 hours later.

Actors may be able to stand before a cold microphone, script in hand, and render a convincing vocal delivery if unseen, but the best of them cannot face a camera before a black back-drop with no props, and make anyone believe that they are playing a bedroom or kitchen scene. Properties and set dressings, along with costumes, are vital to realism.

ANOTHER ROAD TO REALISM

This latter item suggests to the writer another possible inexpensive means of obtaining realism through a combination of actors in the flesh, plus the ordinary movie film as support. Briefly we may unravel this for you by taking as an example the following:—

There may be a short, yet vital, scene which calls for leading players engaging in conversation in Piccadilly Square in London while the balance of the picture might easily be made in California. To save time and thousands of dollars a transparent screen of convincing proportions is set up in the California studio and so too is a projector at some distance behind it. Then from the files or vaults the necessary footage of previously photographed Piccadilly (authentically real with its busses and bicycles buzzing about) is projected upon the rear of the transparent screen. Next the actors are placed slightly in front of the same screen. After they are independently lighted the composite is recorded and photographed as though they were in Piccadilly.

It is all very simple and inexpensive. Even such tricks in production can be chiseled down to basic necessities. Two

people conversing in a cab need but the rear tonneau and seat which could be caught up from some junk yard. The scenery in such a setup would only be projected through the rear window of the cab.

There is no reason why such facilities could not be set up to reduce costs in television. Should there be temporary obstacles, they will be overcome, they always are.

Tangible evidence of that fact can be had if we peek into the laboratories of the 3 major broadcasting companies. They have kindly permitted us to use the illustrations supporting this article and to present you with some of the facts in the following paragraphs.

N.B.C.—As he has for the past 12 years, vice-President O. B. Hanson of N.B.C. continues to keep his organization well in advance of the years. We find the N.B.C. with their transmitter atop the Empire State Tower dealing in doubles as usual. Not content that coaxial cables are the best means of communication between their studios in the RCA Building on 50th Street and their tower transmitter on 34th Street in New York City, they have set up a 2nd connecting channel. On the 10th floor of the N.B.C. plant they have an ultra-highfrequency radio transmitter. This link transmitter, as they call it, operates on a frequency of 177 megacycles. Its antenna in Radio City is aimed at a similar target on the 85th floor of the Empire State Building. Here surely is a clean-cut example of "Romance in Engineering." Which will ultimately win that race, the land line, or the radio channel?

Within the same N.B.C. studios we unearth another combat of great importance to the backers of television tomorrow. Projection of movie film through this new medium will naturally assert itself very prominently. They have nicely adapted their normal-width 35-mm. projectors to meet the television requirement of 30 frames per second. The point of interest is not that, but rather the future of the small 16-mm. projectors lurking sinisterly beside their big brothers. If these little fellows win out in their battle it will mean the saving of many thousands of dollars annually in the difference of cost of picture production.

(Continued on opposite page, top)

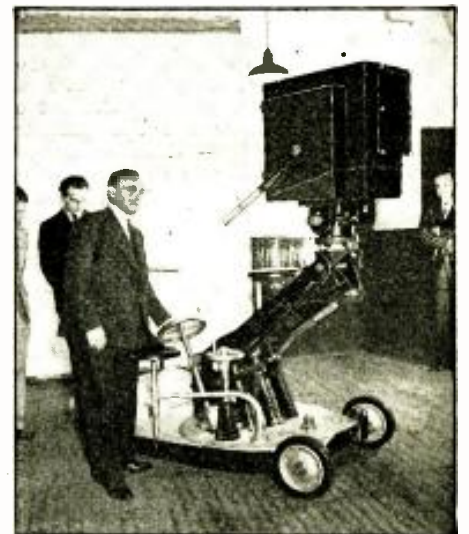

Gilbert Seldes, experimental program director for television at C.B.S., inspects one of the latest cameras. Dr. Peter Goldmark, chief television engineer, is at back, right.

Please Say That You Saw It in RADIO-CRAFT

M.B.S.—Perhaps less active with their publicity but not with their engineering, the Mutual Broadcasting System has divulged the fact that Mr. John R. Poppe, their chief engineer, is due back from Europe shortly before this article is released. Apparently that organization intends to let no foreign development elude its scrutiny.

C.B.S.—The mighty Chrysler Building's upper floors in New York City had to be reinforced with more steel to accommodate the 30-kilowatt transmitter with which the Columbia Broadcasting System will serve you from its recently-constructed television studios, 70 stories below, in Grand Central Station. Under the direction of Gilbert Seldes these studios predict the least possible picture distortion, firstly because their lofty antenna will be only 90 feet from their transmitter on the 74th floor of the tower, and secondly because it tops any steel structures between it and residential areas. Radiating 441 lines on a frequency somewhere between 42 and 56 megacycles, C.B.S. anticipates a 40-mile radius. That being equivalent to a coverage of about 4,800 square miles of the densely populated metropolis.

Contrasting this to their 60-line images over W2XAX on 2,800 kilocycles 5 years ago, we must again admit television will be a buxom babe demanding respect once he gets on his feet.

NEW CIRCUITS IN MODERN RADIO RECEIVERS

(Continued from page 141-142)

ations of the cathode will be in such phase as to cancel some of the signal input. This action is known as *degeneration*. In the beam type of tube, however, it works to advantage as the construction of the beam tube causes it to produce considerable 2nd-harmonic energy. This degenerative action greatly reduces the 2nd-harmonic energy and all higher harmonic energy to a greater proportion than the fundamental. The connection is, therefore, widely used with single-tube output circuits using the beam tube. The circuit also permits a greater signal input to the tube and the use of a higher grid resistance than would be otherwise possible.

(5) LINK-CIRCUIT HIGH-FIDELITY SYSTEM

RCA Victor Model HF-1. A 1st I.F. coupling circuit which transfers a maximum amount of signal energy with appreciably no effect on the band width of the plate and grid series coils is shown in Fig. 2C.

For maximum selectivity, the lower ends of coils L5 and L8 are grounded. A single link circuit is thus formed. Because of the ratio of reactances of C5 and C7, less than 1 per cent of the voltage across L5 is transferred to L8. When the lower ends of coils L6 and L10 are grounded, the others being free, the impedance at each end of the link circuit is greatly increased and a much higher signal voltage is transferred, and due to the greatly increased coupling a broader band of frequencies is passed. Finally when the lower ends of L7 and L11 are grounded, there are 3 coils in series at each end of the link circuit. This still further increases the coupling at each end of the link circuit, increases the impedance, increases the signal voltage and broadens the transmission band.

NEXT MONTH
Special Test Instruments Number

Buy TECO and SAVE the Difference!



NEW TECO MULTIMETER

MODEL T-15 Here's the unit you need for rapid, accurate measurements. A 1000 ohms per volt type instrument featuring a 4 1/2" modern d'Arsonval type movement 0-1 Milliammeter. Accuracy 3%. Attractive etched metal panel. For use on 110 V., 60 cycle AC. 2 RESISTANCE RANGES. 0-500 ohms, 500-5 megohms. HIGH AND LOW CAPACITY SCALES. .0005-1 mf. and .05-200 mf. COMPLETE AC and DC VOLTAGE and CURRENT RANGES. DC Voltage: 0-15, 0-150, 0-750 volts; AC Voltage: 0-15, 0-150, 0-750 volts; DC Current: 0-1, 0-15, 0-150, 0-750 ma.; AC Current: 0-15, 0-150, 0-750 ma. THREE DECIBEL RANGES. TECO Multimeter comes complete in black leatherette carrying case with test leads and instructions. Size 11 1/2 x 8 1/2 x 5 1/2". SHpg. wgt. 3 lbs. Our net price.....

\$13.60



NEW TECO TUBE TESTER

Model T-10 A genuine achievement! For accurate and rapid work. Has d'Arsonval moving coil meter. Tests all types of tubes. For use on 110 V., 60 cycle AC.

Features • Tests all 4, 5, 6, 7s, 7L and octal base tubes. • Tests by the well established emission method for tube quality, directly read on the Good? Bad scale of the meter. • Affords separate neon test for leakage and shorts between elements. • All services performed with 5 controls at maximum—many tests not requiring all controls. • Modern attractive etched panel housed in rugged leatherette carrying case with removable hinged cover and handle. • 60 cycle AC operation. • Supplied with instructions and reference table covering all tubes which you will commonly encounter in servicing. Size 11 1/2 x 9 1/2 x 5 1/2". Net Price.....

\$11.75

FREE! New Catalog Just Off Press Shows Entire Line!

TEST EQUIPMENT COMPANY of AMERICA
139 CEDAR ST., DEPT. RC-9. NEW YORK, N. Y.

A Guide for Your Protection in Purchasing Antenna Kits

ALL-WAVE Antenna Systems Standardized and Licensed under patents No. RE 19854 and others owned by Amy, Aceves & King, is your assurance of receiving the most modern antenna equipment and noise-reducing installation available.

Many companies, including the following, are selling properly licensed All-Wave Antenna Kits manufactured under the above patents rights, owned and controlled by Amy, Aceves & King, Inc., and guaranteed to have our latest noise-reducing features. Among the Antenna Kits licensed by Amy, Aceves & King are the following:

- Allied Radio Corporation—Type B-3391
- Andrea Radio Corporation—Model 50 DeLuxe All-Wave Kit
- Belden Mfg. Company—Types 8907 and 8901 All-Wave Systems
- L. S. Brach Mfg. Corp.—Types BD-400, GS-500 and 990
- Continental Wire Co.—Catalog No. 450 Selecto-Matic Antenna
- Cornish Wire Co.—"Noisemaster," Types 14, 18 and 19
- Emerson Radio & Phonograph Corp.—Type W-5 All-Wave Kit
- Fairbanks, Morse & Co.—DeLuxe All-Wave Antenna Kit
- General Electric Co.—Type FT-60 DeLuxe All-Wave Antenna
- Montgomery Ward & Co.—Cat. No. 7032 All-Wave Kit
- Philadelphia Storage Battery Co.—Phileo High Efficiency Aerial
- Pilot Radio Corp.—Type DX-10 All-Wave Antenna
- Sears, Roebuck and Co.—DeLuxe All-Wave Kit
- Sparks-Withington Co.—Sparton DeLuxe All-Wave Kit
- Stewart-Warner Corp.—DeLuxe All-Wave Kit
- Stromberg-Carlson Tel. Mfg. Co.—No. 5 DeLuxe All-Wave Kit
- Technical Appliance Corp.—Catalog Nos. 210, 301, 400 and 510

AMY, ACEVES & KING, INC., Consulting Engineers 11 WEST 42ND STREET, NEW YORK CITY

Please Say That You Saw It in RADIO-CRAFT

RADIO TRADE DIGEST

\$'s & #'s

(Continued from page 160)

STATIONS

Nation's stations split a \$114,222,906 gross in '37, netting \$18,883,935 for the year's work (not allowing for investment estimated to be \$46 million).

Biggest item of income, time sales by stations (\$80,000,000); next, same by nets (\$36,000,000); 3rd, sale of talent, etc. (\$11,250,000); greatest expense, programs & talent, inc. sustainings (\$32,500,000); next, salaries to officers, execs. & staffs, except program, adv. & sales (\$20,000,000).

In May of this year, CBS, NBC & MBS averaged 2.5% over '37. Breakdown shows NBC up 7.1%, MBS up 25.6%, CBS down 4.6%. But for the first 5 months of '38, all were up, the % being NBC 5.3, MBS 8.7, CBS 9.2.

EXCISE TAX

Reflecting decreased business, the Federal 5% excise tax collections dropped 42% for '38's 1st quarter. The figures:—1938, \$887,579; 1937, \$1,509,353. March was better than the 2 preceding months, the drop being only 31% to \$249,256.

G-E RADIO SALES

While G-E's total billings for the 1st quarter of 1938 dropped 11% (to \$65,086,557) and profits for dividend 39% (to \$7,075,739) for the 1st quarter, Maxon, Inc., N.Y. distributor, reported sales of radios for the 1st 5 months were 50% ahead of the same period in '37.

No conclusion can be based upon so little data, but if straws show which way the wind blows, this straw shows the radio wind blowing upward.

TELEVISION'S HERE— THE SAME OLD WAY

(Continued from page 160)

Subsidiary was first formed as Television Corp. of Amer., but changed to American Television Corp., for stated reason that similarity with RCA might have been confusing.

Images produced by ATC (née CSI) sets are acceptable, but Radio-Craft cost-analysis engineers, inspecting product, put a \$150 production cost on it, making it an impossible \$175 retailer through stores. Tubes used include 1 each 885, 59, 6H6, 25F6, VG27, 2-77's, 4-1851's, plus oscilloscope C-R tube & 2 rectifiers. Add cost of chassis, power packs & cabinet. And what have you got? A business or a promotion?

SALES HELPS & DEALS

(Continued from page 160)

Arcturus Tubes. Offers its dealers all sorts of ad material from calendars & signs to book matches & movie slides. Also mats & electros. Special deal on shop & office equipment.

Sylvania Posters. Reminded consumers that good tubes are needed to hear fights, as Louis-Schmeling. (Remember the Louis-Baer fight coming soon.—Ed.)

Ken-Rad Tube Tester Deal. Offers a Daco 501 on special deal for 300 tubes within a year. Dealers get tester at a liberal discount.

RCA Tube Displays. First unit has 6 action figures (litho-ed on cardboard)

carrying placards advertising tube tests, check-up service, etc. Other units are planned to have seasonal appeal—e.g., a football display. Posters & window streamers will supplement major display units.

Phileo "Drives." Idea is apparently to make the public conscious of wants.

(1) A drive to sell P.A. systems to political groups throughout U.S. for summer & fall campaigning.

(2) Radio service deal. This was run for 2 weeks at beginning of baseball season. 2,000,000 announcements of the flat rate for check-up plan, with attached inquiry coupons, were given dealers to distribute. (A good plan to keep in mind for the football season.)

OFF THE PRESS

(Continued from page 161)

nical & other articles. Illustrated. Issued every other month. Free from mfr.

Arcturus Tube Data Chart. Shows characteristics, connections, etc., of all tubes.

Utah Catalog Inserts. Utah Radio Products Co., Chicago, Ill. Among other things, introduces a new line of xmmitter kits.

Champion Tube Chart. Champion Radio Works, Danvers, Mass. 10 pp. Characteristics & replacement nos. of all standard line resistor ballast tubes, with diagrams showing connections.

National Radio Products. National Co., Inc., Malden, Mass. 16 pp. Bulletin 280 lists several new products, many established favorites. 2 new communications receivers featured.

Ken-Rad Tube Chart. Ken-Rad Tube & Lamp Corp., Owensboro, Ky. Characteristics & connections.

Meissner Products. Meissner Mfg. Co., Mt. Carmel, Ill. 44 pp. New & established apparatus, with confidential net prices.

Bulletin GEA-2021A. General Electric Co., Inc., Schenectady, N. Y. Shows reduced prices on Pyranol capacitors (fixed condensers). New prices are as much as 42% below former figures. Free to dealers, distributors, etc.

Exact-Duplicate Replacement-Condenser Wall Chart. Aerovox Corp., 70 Washington St., Brooklyn, N. Y. Lists various standard receivers alphabetically & by model numbers, with set manufacturer's part number, capacity, D.C. working voltage, type of container, dimensions, and list price of replacement. Free to all who handle the line.

Weston Pointer, Vol. 1, No. 1. Weston Electrical Instrument Corp., Newark, N. J. 4 pp. test data, A.F.C. alignment data, and institutional promotion. Free to trade and users of Weston's instruments.

Weston Tube Test Data Chart. Issued by above. "Testing data on practically every tube in use today". Free to owners of Weston Tubecheckers who send mfr. their registration cards, or serial numbers of their tubecheckers. Forthcoming issues will likewise be sent free.

HOT BUSINESS

Old Story: "I'm insulted. The boss told me to go after business. And I just realized where business has gone to." Once good for a laugh, the story ceased to be funny when industry realized that the only way to get business out of its hell was to go after it and bring it back. Entailing "going through hell" for the ambitious, it nevertheless has commensurate rewards. Business will stick to the men who save it.

AMPERITE offers ADJUSTABLE RESPONSE*

...made possible by THE ACOUSTIC COMPENSATOR

(pat. pend.)

ADJUST TO
HIGHER OR
LOWER
PITCH FROM
STANDARD
TONE



*Higher or lower pitch with the same microphone.

With the flip of a finger you can now (1) lower or raise the response of the microphone. . . (2) adjust the microphone for most desirable response for close talking or distant pickup. . . (3) adjust the system to any "taste", room condition, or equipment.

MODELS RBHK. RBMK. with Acoustic Compensator. frequency range 40 to 11000 cps. output, -65 db., complete with switch, cable connector and 25' of cable. \$42.00 LIST

NEW LOW-PRICED CONTACT "MIKE"

Model SKH (hi-imp); SKL (200 ohms) \$12.00 LIST

MODELS RAH-RAL. excellent for speech and music. Reduce feedback. \$22.00 LIST

Write for Complete Illustrated Bulletins and Valuable Sales Helps.

AMPERITE Co. 561 BROADWAY, N. Y. Cable Address: Alkzem, New York

AMPERITE Velocity MICROPHONE

SEEKING RICHES FROM THE EARTH BY RADIO

STEADILY the technique is developing for the location of precious ore bodies and other mineral deposits in the earth by using radio. A very comprehensive article has been prepared, revealing circuits and methods, all based on verified experiments, giving full insight into this fascinating and promising field. By using methods now fully disclosed, gold coins, buried by prearrangement, were recovered, to the consternation of amazed onlookers.

All the world over, the eager search for the riches reposing in the recesses of the earth goes on. Success attends those efforts that scientifically determine the non-homogeneous character of the earth. Interpretation of these findings determines the straight path to precious deposits.

Acquaint yourself with the full facts about the earth as a treasure chest, and the exploration by radio devices by those seeking riches. Be among those fully conversant with the requirements for successful apparatus. Join in the treasure-seeking yourself. The full details are revealed in the article that treats of this historic development of methods of wresting the secrets from the earth, from the first divining rod to the latest high-powered beat oscillator. Remit with order.

25¢
POSTPAID

RELIABLE RADIO COMPANY
143 West 45th Street, New York, N. Y.

Please Say That You Saw It in RADIO-CRAFT

RADIO TRADE DIGEST

SCOOPS & SNOOPS

(Continued from page 161)

wind-driven generators, & liberality of its offer to salesmen

Astatic Microphone Lab., Youngstown, O., dropped the price of Tru-Tan 0-7 pickups from \$12 to \$6.50—and the replacement cartridge alone used to list at \$6 *General Transformer Corp.*, Chicago, has new line of PeeWee xmitters, the leader a 5-band 25-watter at \$19.95 complete That big multi-tube 2-band table model super. that was price-cut to \$12 in N'yawk turned out to be a *Kadette 1019AC* *Arcturus Radio Tube Co.*, Newark, has its chest sticking out over a Jersey state Award of Merit for a perfect 1937 Safety record

Ed. F. McGrady's now an RCA V-P Walter W. Boyd, of Chi., will represent *Mueller Elec Co.* in Ill. & eastern & southern Wis., while Fred Somers takes over Mo., Ia., Neb. & Kan. . . . *All Wave Radio* magazine, depression-struck, was taken over by *Radio News* RCA has upped its advertising appropriation 20% for the 1939 radio & phono line. Plans include newspaper, magazine & broadcast ads G-E is planning campaign in same types of media *Arcturus* has made & sold more tubes in 1st ¼ of '38 than in any other year; plant is running on full time *Universal Microphone Co.*, Inglewood, Calif., announces Model 5MM, 40-10,000 c.p.s., -66db., wt. 1 lb. . . .

Bakelite's new loloss molding material, *Polystyrene*, has loss factor below .00053, power factor below .0002, dielectric constant of 2.60, dielectric strength over 500 volts-per-mil *Heintz & Kaufman, Ltd.*, of San Francisco, have been granted a non-exclusive RCA license on ship, plane and other equipment, thus ending a patent squabble Another squabble flopped when N. Y. State Supreme Court awarded *Sales-On-Sound Corp.* (N. Y. C.) \$5,000 from *Consolidated Theater Supply*, et al., in a "customer stealing" suit

Graham McNamee & Milton Cross, attention! Larry Roller, WCK-WCLE, claims title of America's Most Experienced Radio Announcer. Does he get it? *Wholesale Radio Service*, N. Y., reports sale of 30-watt portable P.A. system to Freddie Fisher & his Schnickelfritz Band. Hot idea for some of you other dealers: why not solicit local bands? *Wholesale Radio Service* press agent pulls a Barney, sending swell release, followed next day by letter asking it be killed "for reasons best known to ourselves". Why, WRS, oh why?

David Sarnoff, RCA prexy, sees indirect censorship in FCC licensing system; no record at hand of any proposal for better system Why do human minds perfect a wonderful instrumentality like radio and then use it for stuff like 80% of the bilge that's broadcast? "1 to 9" club, of *Midland Television* (Kansas City, Mo.) students have been assigned W9KGF for its 100-watter *International Nickel Co., Inc.*, N. Y. C., announces new nickel-copper-iron permanent-magnet alloy with unique machining & fabricating characteristics

British trade pubs. give tips on shop demonstrations of television; why can't it happen here? Luxury trailers to be used by Com. Attilio Gatti to explore Bel-

gian Congo will have 2-way radio (by G-E) with 60-mile radius.

CHANGES IN NAMES & ADDRESSES

(Continued from page 161)

Air-King Products Co., Inc. 1523-29 63rd St., Brooklyn, N. Y. C. Complete line of domestic and export receivers.

Littelfuse Laboratories. Recently incorporated under the name *Littelfuse, Inc.*, at the old address, viz.: 4238 Lincoln Ave., Chicago, Ill. Executives: E. V. Sundt, Pres.; B. Kollath, Vice-Pres.; Thomas M. Blake, Sec'y-Treas. Complete line of delicate electric protective devices.

John F. Rider, Publisher. 404 4th Ave., N. Y. C. Publishers of service manuals and technical books.

Commercial Radio Equipment Co. 7134-36 Main St., Kansas City, Mo. They offer broadcasters "the largest independent frequency-monitoring service in the country."

The Illinois Condenser Co. 1160 N. Howe St., Chicago. Executives are: J. J. Kurland, Pres.; J. K. Kurland Sec'y-Treas. Complete line of service condensers. Exclusive jobber retail business.

Communicating Systems, Inc. Changed its name to *Television Corporation of America* and then a few days later to *American Television Corp.* Address, 130 West 156 St., N. Y. C.

YOU! YOU!! YOU!!!

Are you moving? Have you moved recently? Do you plan to move soon? If so, send your new address to *Radio Trade Digest*, Radio-Craft, 99 Hudson Street, New York, N. Y.

Don't hide from your customers and potential customers!

PAPERS OUST RADIO

Scared spitless of radio competition, newspapers are renewing their war on radio publicity. 7 of 8 Boston papers have axed their radio columns. 1 has junked all radio. The *Chi. Trib.* has joined the *Chi. News & Chi. American* in killing the daily column, though it retains its Sunday sound-off—and it's the owner of WGN, too. Windy City's *Herald-Examiner & Times* continue the cols.

Despite the unfriendly attitude of nation's Press, stations deny that reprisals are planned, though there has been talk of a new radio news syndicate, publishing a paper for free distribution to listeners. Its support is planned to come from advertising of radio sponsors.

NEXT MONTH— BIGGER & BETTER

Four full pages—a complete miniature newspaper of the radio trade—that's what *Radio Trade Digest* promises you for next month. Send in news about your firm, its activities and its personnel, its products and its sales methods. *Radio Trade Digest* is deeply interested in YOU.

Please Say That You Saw It in RADIO-CRAFT

MODERNIZE YOUR SERVICE SHOP



THIS BOOK SHOWS YOU HOW!

A serviceman's biggest asset in business is a completely modern, completely efficient service shop.

Let this book help you modernize. It contains full working plans and specifications for the construction of today's model service shop—identical to the one we displayed at the National Trade Show in Chicago.

Following these plans, you can build the complete shop at very moderate cost. But even if you wish only to modify your present set-up, this book will be helpful. It contains many valuable tips—ideas and suggestions you can really use in modernizing your shop. Send the coupon and 10c for this book today. You'll be glad you did. Hygrade Sylvania Corp., Emporium, Pa.

Also makers of famous Hygrade Lamp Bulbs

SYLVANIA set-tested radio tubes

Hygrade Sylvania Corp. RC-98 Emporium, Pa.

Here is 10c. Please send me the Sylvania Model Service Shop book right away.

Name

Address

City State

Amateur Serviceman
 Dealer Experimenter

Name of Jobber

TELETRAN

!!!

**MOST COMPLETE
LINE OF PA
and ACCESSORIES
ON THE MARKET
TODAY.**

↓

Write for 20-page Catalog.

*

Licensed by ERPI under patents owned or controlled by A. T. & T. and Western Electric

TELETRAN PRODUCTS CO.
2233 University Ave.
St. Paul Minnesota

G.E. PHONOGRAPH MOTOR

Formerly Sold for \$15.00



\$4.95

Only

VARIABLE speed induction type self-starting, 110 volt, 25 to 60 cycle, A.C. with speed control. Plug and cord. Speed range from 5 to 200 R.P.M. Can be installed in place of old-fashioned, hand-winding speed motor. Also ideal for display turn table, and a hundred other uses. These General Electric Motors are brand new, in original factory cartons. \$4.95

G. E. Electric Phonograph motor as described

Shipping Weight—12 lbs.

MICROPHONE and RECEIVER



TRANSMITTER, EAR CAPS, HEAD SET, BREAST PLATE, MIC SWITCH, TWO CIRCUIT JACK, 28 FT. HEAVY INSULATED CABLE

THIS Microphone and telephone headset outfit was built especially for the U. S. Navy Aviation Corps. The Holtzer-Cabot Electric Company constructed the outfit to Government specifications. The outfit consists of a low-impedance carbon microphone (transmitter), securely fastened to a metal breast-plate, and a set of heavy-duty, low-impedance earphones. A specially constructed switch on the back of the breast-plate controls the microphone circuit. The earphones are U.S.N. "fish" type, attached to adjustable headband. Twenty-eight feet of very heavy weather and waterproof conductor cable is furnished. Current of not more than 10 volts should be used. A storage battery is the most satisfactory current supply. U. S. Navy Airplane-type Microphone and Receiver as described \$4.96

Shipping Weight—9 lbs.

Shipping Weight—9 lbs.

We will forward Shipments by Express Collect if sufficient postage is not included.

WELLWORTH TRADING COMPANY
560 W. Washington Blvd., Dept. RC-938, Chicago, Ill.

HOW TO MAKE A 3-OCTAVE ELECTRONIC ORGAN FOR \$20

(Continued from page 145)

are drilled through this lever. One is 1½-ins. and the other is 2 ins. from the front. Fig. 5B.

The volume control rod is a clothespin sawed off at the manufacturer's notch. Corrugate the top with a file. Three-eighths-inch from the rear drill a hole for the shaft of the volume control. Through the rear a ¼-in. hole is made for a set-screw. When the lever is placed on the shaft of the volume control the shaft will extend through the lever. Saw the shaft so that it is level with the top of the lever. Insert a woodscrew into the shaft slot so that a tight mechanical joint is produced. See Fig. 5C.

Two levers are necessary for the accidentals. The levers are mounted on their sides as compared to the note levers. A 5/32-in. hole is drilled 1½ ins. from the front. Measurements for contact holes are the same as for the other levers. See Fig. 5D. Beneath the accidental levers and the volume control rod, washers are placed for smoothness of movement.

The accidental stator contact-holders are made by sawing 2 levers. The measurements are shown in Fig. 5E.

The accidental levers move from side to side and swing back to position by the action of springs bent as shown in Fig. 5H.

Contacts of all levers are made by cutting flexible wire such as dial cable into 2-in. lengths. Run the wire through the 2 holes and solder them at the top of the lever (Fig. 5F).

Stationary contacts for the notes are made by cutting 2 strips of metal (1 for notes of the left hand and 1 for the notes of the right hand) and placing them on the keyboard underneath the contact holes of the note levers. Strips of felt are cemented to the underside of the metal to eliminate noise caused by movement of the levers. Small pieces of metal (with felt) are used for stationary contacts under the rear of the high octave and the front of the low octave levers. (See Fig. 5G.) Another anti-noise measure consists of cementing a double layer of felt (F) on the levers as shown in Figs. 5A and 5B.

When mounting levers LO, A, B, C, D, E, F, and G, place the rear screw through a spring under the lever. This in conjunction with the rear notch brings the lever back to a slanted position when a finger releases the lever (Fig. 5J). Beneath the heads of the front screws place a felt washer to eliminate contact noise.

Underneath the "HI" lever 2 springs are set with the screws running through them. All front holes should be large enough to allow free movement of the levers about the screws.

The cover of the case has a 7-in. hole cut for the speaker. Between the cover and the speaker is placed a grille cloth. The grille cloth is cemented to the frame of the speaker. A wooden grille is cemented on the outside of the cover to protect the speaker cone. The size of the case with the cover is 16¾ x 13¾ x 8¾ ins. deep. The cover is 3¼ ins. deep. The case may be shallower but not the cover.

Two hinges permit the earphone to be held in the upper-left-hand corner of the cover. Another at the right side of the cover allows the line cord and the music manuscript to be securely held in place when they are not being used. Hinges should be chosen which do not rotate on their pins easily.

The cover is held in proper position by a sliding-type bracket at the right side of the case.

The keyboard is 1 ft. square. Fastened at its right side with brackets is a board 5 x 10 ins. Two 1½ x 3¼ in. wooden blocks are fastened to the side board to hold V and V1. (See Figs. B and 5I.)

Across the top of the panel 3 double-angled brackets are screwed to act as a music stand.

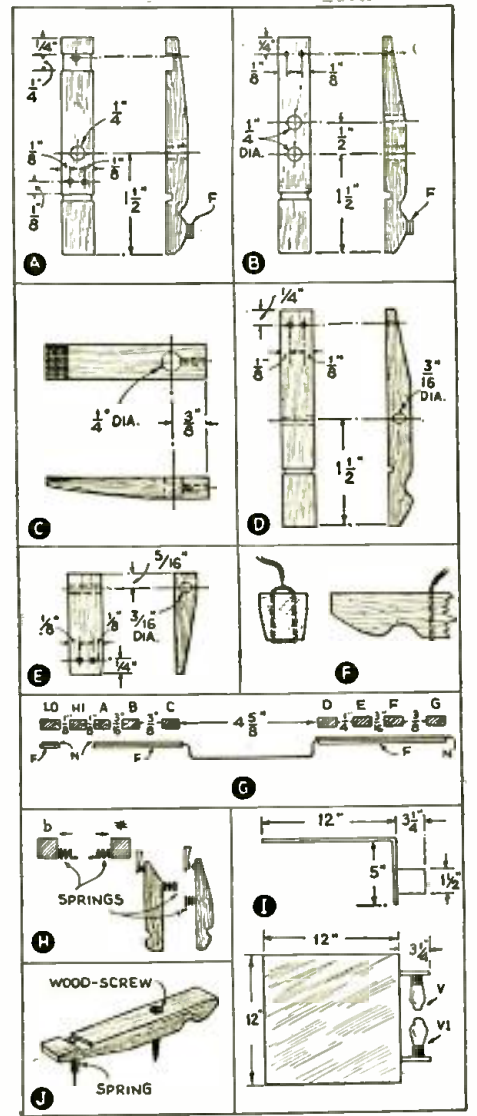

Fig. 5. The experimenter may exercise his own ingenuity in supplying keys for the Electronic Organ; or, as illustrated, he may make them from clothespins.

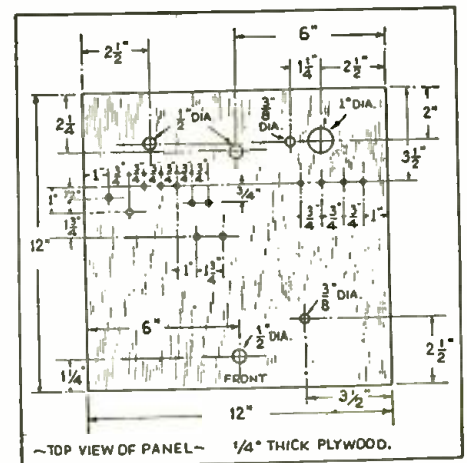

Fig. 7. Panelboard drilling details.

Please Say That You Saw It in RADIO-CRAFT

CONSTRUCTION

Mount the levers and contacts on the keyboard. Then fasten the underside parts with 1/4-in. wood screws. The neon tube socket is held by a wire run across it and fastened to 2 wood screws. The volume control type resistors are held by volume control mounting brackets.

Wire all parts. Switch "S" should be previously wired. This is accomplished by holding the shaft downward and following the connections of S in Figs. 2 and 4. Turn the volume control R2 to a high level.

Turn shaft of S until the rotor contacts the 5 sharp (7 flat) position. Resistor R4: start tuning (by ear or with the aid of an instrument) with the A flat tap. Keep taps toward the free end of R4 as shown in photograph. Tighten the taps just enough to keep them from moving. If the taps are tightened too much, the winding of R4 may be injured. Do not move a tap while a key is depressed. After tuning this position turn the switch shaft until the contacts rest at position O to tune. Follow this by checking the tuning with switch "S" in the 5 flat (7 sharp) position. The accidental taps must be tuned also. Octaves are tuned by adjusting the screws of the semi-variable capacities C3 and C4.

The levers are covered by cardboard shields which are bent at the front and sides. Identification of each lever is printed on the front of the shield, as shown in Fig. 6.

OPERATION

To operate this instrument turn the line switch on and wait until V2 glows. Look at the key signature on the music and turn S_R to the number of flats or sharps designated.

Place the smallest finger of the left hand above the octave levers and press "LO" if the low octave is desired and "HI" if you wish the high octave to be reproduced. The thumb is placed between the accidental levers and is moved to the left to lower any note 1/2 a tone or to the right to raise any note 1/2-tone. The right-hand digits rest on the D, E, F, and G notes while the thumb controls the volume. Play one note at a time.

It is advisable to paint the front portion of the levers with a dark-colored paint

unless the tops of piano keys can be obtained to cement on the levers.

The lettering on the switch "S" dial plate indicating the number of sharps should be of another color than the lettering indicating the number of flats. The letters on the key-changing switch (S) plate correspond to the letters used in Figs. 2 and 4. Use the audio transformers specified, for correct results on all octaves.

The tone quality is proportional to the speaker size. The specified speaker is 8 1/2 ins. in dia.

All levers are easily adjusted to any individual predilection by manipulation of the lever screws.

Now as to the considerations mentioned at the beginning of this article. Ease of Operation: The most important aid to facility is the key changing switch because it allows the musician to play in the "C" key signature on all occasions. The octave, earphone, and accidental design should be admitted to the list of decided advantages.

Tonal quality can be altered to suit the musicians' desire.

Apropos of the physical shape and weight: The weight is about the same as an alto saxophone and it is carried as easily.

Last but extremely important is the low cost. All parts of this instrument total, in price, to about \$20.00. The actual cost of course will vary in every instance, depending upon local prices, parts on hand, etc.

The writer hopes that the several features he has incorporated in this new type of musical instrument, to achieve economy of design and simplicity of operation, will aid it to be marketed at an early date.

LIST OF PARTS

- One type 25Z5 tube, V;
 - One type 76 tube, V1;
 - One General Electric neon lamp type, N1, V2;
 - One Dependable 7-gang, 12-point rotary switch—S(s) is the stator, S(r) is the rotor—S;
 - One General Electric rotary switch, S1;
 - One Trutest filter choke, 10 hy., 200 ohms, L;
 - One Trutest 3 1/2 to 1 ratio audio transformer, T1;
 - One Amplifier Co. of America audio transformer, type EM, T2;
 - One Solar dual filter condenser, 8 mf., C;
- (Continued on following page)*

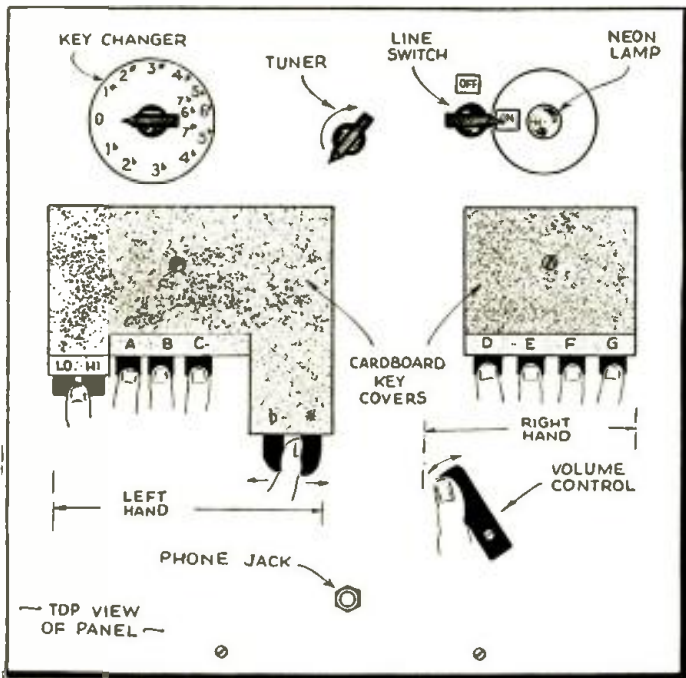

Fig. 6
Every artifice of which musician-experimenter Groder was capable has been employed to reduce the cost and increase the convenience of this Electronic Organ. Clothespins for playing keys; and 2 Octave keys to reduce, by 2/3, the number of playing keys; and 2 Accidental keys to still further reduce, by 1/2, the total number of effective playing keys!

Please Say That You Saw It in RADIO-CRAFT

300 WAYS

To Make Money 10¢

68 PAGES



SOLD ON A MONEY-BACK GUARANTEE!

MAIL ORDER PLANS TESTED MONEY MAKERS BUSINESS SECRETS SUCCESS SCHEMES

25 CENTS

Regular Price 25c Special at 10c for short while only.

In "CASH IN" you will find over 300 ways to make money—dozens of profitable tested mail order plans, confidential business secrets, dozens of practical tested formulas, sources of supplies, successful, and honest tested schemes—many actual experiences of men who have started on the proverbial shoestring—with less than \$10 capital.

Buyers of This Book Tell Us—

"The biggest dime's value I've yet to see. The book is worth at least one dollar." SAMSON BUDA, Brooklyn, N. Y.

"Your book is as good if not better than others selling at \$1.00." GEORGE BRUNET, Montreal, Canada.

"CASH IN is the best value I have yet to see in the mail order field." LAWRENCE FOX, Brooklyn, N. Y.

"CASH IN" contains 68 pages of tested ideas covering every type of full- or spare-time enterprise—it is really a "masterpiece" in business ventures—OVER 40,000 WORDS IN THE TEXT.

Sent POSTPAID anywhere in U.S. upon receipt of ten cents in stamps or coin.

Remember—your money back if not satisfied.

NATIONAL PLANS INSTITUTE
246-R FIFTH AVENUE NEW YORK, N. Y.

FREE TRIAL OFFER

NEW REMINGTON NOISELESS PORTABLE! AS LITTLE AS



10¢ A DAY

Famous Remington Noiseless Portable that speaks in a whisper. Pay as little as 10¢ a day. Guaranteed by the factory. Standard keyboard, Automatic ribbon reverse. Variable line spacer and all the conveniences of the finest portable ever built. PLUS the NOISELESS feature. Act now. Send coupon TODAY for details.

You don't RISK a Penny

We send you Remington Noiseless Portable for 10 days' free trial. If not satisfied, send it back. We pay all shipping charges.

Typing Course and Carrying Case

You will receive FREE a complete simplified home course in Touch Typing, a handsome sturdy carrying case is included. No obligation. Mail coupon for full details—NOW.

Remington Rand, Inc., Dept. 189-9, 465 Washington St., Buffalo, N. Y.

Tell me, without obligation, how to get a Free Trial of a new Remington Noiseless Portable, including Carrying Case and Free Typing Course for as little as 10¢ a day. Send Catalogue.

Name
Address
City..... State.....

DO YOU LIKE RADIO & TELEVISION

If you want to know employment opportunities and requirements in radio and related industries, get National's book of facts. **Send for YOUR FREE COPY TODAY**



NATIONAL SCHOOLS
Los Angeles

HOW TO MAKE A 3-OCTAVE ELECTRONIC ORGAN FOR \$20

(Continued from preceding page)

- One Solar paper condenser, 0.1-mf., C1;
- Two mica condensers in parallel, 0.001-mf., and 250 mmf., C2;
- One paper condenser, 0.004-mf. and one Meissner Jr. trimmer condenser in parallel, C3;
- Three mica condensers, 0.01-mf., 0.006-mf., 0.002-mf., and one Meissner Jr. trimmer condenser in parallel, 1,125 mmf., C4;
- Two Solar paper condensers in parallel, 0.1-mf., and 0.02-mf., C5;
- One line-cord resistance, 280 ohms, R;
- One I.R.C. resistor, 6,000 ohms, 1 W., R1;
- One Yaxley volume control, 4 meg., R2;
- One Trutest wirewound resistor, 30,000 ohms, 10 W., R3;
- One I.R.C. variable resistor, type ESA, 0.1-meg., 80 W., R4;
- One Yaxley volume control, 0.5-meg. (used as tuner), R5;
- One Yaxley double-circuit jack, J;
- Felt, F;
- One Trutest balanced-armature magnetic speaker, type K19119, SP;
- Six clothespins, spring type, L;
- Metal strips, N;
- Earphone;
- Phone plug;
- Two rubber grommets (for line cord and speaker cord);
- Three bakelite knobs (pointer style);
- Neon lamp socket with flexible leads;
- One Eby 5-prong socket;
- One Eby 6-prong socket;
- Phosphor bronze dial cable;
- Four angle brackets;
- Three double-angle brackets;
- Three hinges;
- Two Trutest mounting brackets for volume controls, type K6298;
- One dozen 3/8-in. springs, compression type;
- One wooden panel, 12 x 12 ins.;
- Two wooden blocks, 1 1/2 x 3 1/4 ins.;
- One wooden board, 5 x 10 ins.;
- One grille cloth, 9 x 9 ins.;
- One slide-type bracket;
- One carrying case, 16 3/4 x 13 1/4 x 8 3/4 ins. deep;
- Twenty 3/4-in. round head wood screws;
- Wood screws, 1/4-in.

BUILD THIS 38-RANGE "PUSHBUTTON" BENCH TESTER

(Continued from page 140)

- One I.R.C. precision, type WW4, 4.16 ohms, R39;
- One I.R.C. precision, type WW4, 1.01 ohms, R40;
- One I.R.C. precision, type WW4, 0.401-ohm, R41;
- One I.R.C. precision, type WW4, 0.20-ohm, R42;
- One I.R.C. potentiometer, type 11-108, 1,000 ohms, R4;
- One I.R.C. potentiometer, type 11-116, 10,000 ohms, R12;
- One I.R.C. dual rheostat, type JS-968, 1,000 and 50,000 ohms, R16;
- One I.R.C. potentiometer, type 11-108, 1,000 ohms, R25;
- Two Mallory-Yaxley wire-wound potentiometers, 9 watts, 10,000 ohms, R22, R31.

CONDENSERS

- Six Solar, type MP4140, 0.1-mf., C1, C2, C3, C4, C5, C9;
- One Solar, type P1901, 2 mf., 200 V. paper, C6;
- One Solar, type DE918, 8 mf., 200 V. elec. C7;
- One Solar, type P1901, 1 mf., 200 V. paper, C8;
- One Solar, type SO226, 0.05-mf., tubular, C10;
- One Solar, type MW1221, 400 mmf., mica, C11;
- One Solar, type XC-11, 1 mf., 1,000 V. oil-filled, C12;
- Three Solar, type XK16, 16 mf., 450 V. wet elect., C13, C14, and C15;
- One Solar, type SSO309A, 0.05-0.05-mf., 600 V., C16;
- One Solar, type SO226, 0.1-mf., tubular, C17;
- Two Solar, type MO1416, 100 mmf. mica, C18, C19.

SWITCHES

- One Mallory-Yaxley pushbutton, type No. 2160, Sw.1;
- One Centralab Selector, type No. 1403, Sw.2;
- Two Centralab Selector, type No. 1461, Sw.3, Sw.6;
- One Centralab Selector, type No. 1425, Sw.5;
- One Centralab Selector, type No. 1401, Sw.7;

- One Centralab Selector, type No. 1411, Sw.8;
- One Centralab Selector, type No. 1450, Sw.9;
- One thumb type, S.P.S.T. Sw.10;
- Two toggle, for A.C. and P.F. Sw.4, Sw.11.

TUBES

- One RCA 83 mercury-vapor rectifier, V6;
- One RCA 1 V. rectifier, V5;
- One RCA 6F5, V4;
- One RCA 6E5, V3;
- One RCA 6F5, V2;
- One RCA 6G5, V1.

MISCELLANEOUS

- One Triplett 5-inch meter, No. 521;
- One plywood panel, 13 x 17 x 1/4-inch;
- One baseboard, 8 x 17 x 3/4-inch;
- Six wafer sockets, 2 four-prong, 2 six-prong, 2 octal;
- One I.C.A. octal socket and plug, for V.-T.V.M. input tube;
- One Amphenol octal plug, for V.-T.V.M. cable;
- One piece of bakelite tubing, 4 1/2 ins. long x 1 5/16 ins. inside dia.;
- One piece of tubing for each tuning "eye";
- One alligator clip for probe;
- One 5-wire cable 36-ins. long;
- One adjustable resistor clip to fit neck of 6F5;
- One 3-inch dial scale, zero to 100 in 325 deg.;
- One each, male and female A.C. receptacle plugs;
- One A.C. convenience receptacle;
- One Yaxley panel light, type No. 330;
- Four pairs, phone tip-jacks, 4 red, 4 black;
- One pair standoff insulators, 1 in., with banana jacks;
- Twelve bar knobs, 1 1/4 ins.;
- One large bar knob;
- One pair test leads, banana tips and alligator clips;
- One pair test leads, phone tips and needle prods;
- One pair test leads, phone tips and alligator clips;
- One A.C. line cord, 8 ft. long.

Most Radio mail order houses can supply these items if properly identified as to title of article, issue (month) of Radio-Craft and year.

Please Say That You Saw It in RADIO-CRAFT

THE "HIGH SEAS 4" UTILITY LAMP-RADIO

(Continued from page 153)

lead to one of the tie-in strips. Plug the set in again, wait a half-minute for the tubes to heat up and then, with a good 0-150 V. meter, check from the "B+" lead to chassis. The reading should be from 90 to 100 volts.

Now proceed with the wiring of all tube plates and screen-grids, stopping again to check for voltages at these elements before continuing.

By following this procedure you are certain that the set will work properly when you are all through. By the time you get to the R.F. portion of the set you know that everything else is OK. Then if there is any trouble you know where to look for it.

THE LAMP

Made to the author's specifications, the lamp follows a nautical design. The large 12-in. helm is fastened to the shaft of the tuning condenser, so that turning the helm tunes the set. As shown in Fig. A, the tuning scale is marked on the outer rim of the helm, in arbitrary figures of 0 to 100. The scale covers only 1/2 of the wheel circumference since the tuning condenser turns only 180 degrees. The pointer is made of thin brass and attached to the cover of the lamp body in such manner as to be barely above the graduations on the helm. On the underside of the lamp several 1-in. holes are drilled in a circle to form the speaker grille.

The entire lamp is finished in maple, and with its large, marine-motif shade, and its brass anchors and trimmings, forms an attractive and useful piece of furniture.

LIST OF PARTS

One *Meissner* variable 2-gang condenser, 365 mmf. (max.), No. 15114;
 One *Meissner* iron-core det. coil, No. 1497;
 One *Meissner* iron-core ant. coil, No. 7411;
 One *Aerovox* paper cond., 0.02-mf., 200 V.;
 Four *Aerovox* paper cond., 0.01-mf. 200 V.;
 One *Aerovox* paper cond., 0.05-mf., 200 V.;
 One *Aerovox* mica condenser, 0.001-mf.;

Two *Cornell-Dubilier* tiny electrolytic condensers, 150 V., 16 mf.;
 One *Aerovox* mica condenser, 500 mmf.;
 One *Continental Carbon* resistor, type M1, 200 ohms, 1 W.;
 One *Continental Carbon* resistor, type M1, 25,000 ohms, 1 W.;
 Two *Continental Carbon* resistors, type M 1/2, 2 megs., 1/2-W.;
 One *Continental Carbon* resistor, 10,000 ohms, 1 W.;
 One *Continental Carbon* resistor, type M1, 120 ohms, 1 W.;
 Two *Continental Carbon* resistors, type M 1/2, 1/2-meg., 1/2-W.;
 One *I.R.C.* potentiometer, 20,000 ohms, type J-74;
 One *Cornell-Dubilier* electrolytic condenser, 50 mf., 25 V.;
 One *Cornell-Dubilier* electrolytic condenser, 10 mf., 10 V.;
 One *Utah* permanent-magnet 3-in. dynamic speaker, with 3-ohm voice coil;
 *One *Amplifier Co. of America* midget output transformer, unshielded, 7,000-ohm primary and 3-ohm secondary;
 One *Amplifier Co. of America* small-space filter choke, 100 ohms;
 One *Arcturus* type 6K7GT small-space tube;
 One *Arcturus* type 6J7GT small-space tube;
 One *Arcturus* type 25L6GT small-space tube;
 One *Arcturus* type 25Z6GT small-space tube;
 Five octal wafer sockets;
 Two *Goat Radio Co.* tube shields, type G-1207;

And, of course, the lamp, sockets, bulbs, fittings. The lamp can be either home-made or obtained ready-built. Contact the author via *Radio-Craft* for information.

*The original output transformer, supplied with the speaker by *Utah Radio Products Corp.* was too large for this compact radio set hence a smaller one was made up specially by *Amplifier Co. of America*. Both are suitable, so choose the one you want according to the space available in your particular housing.

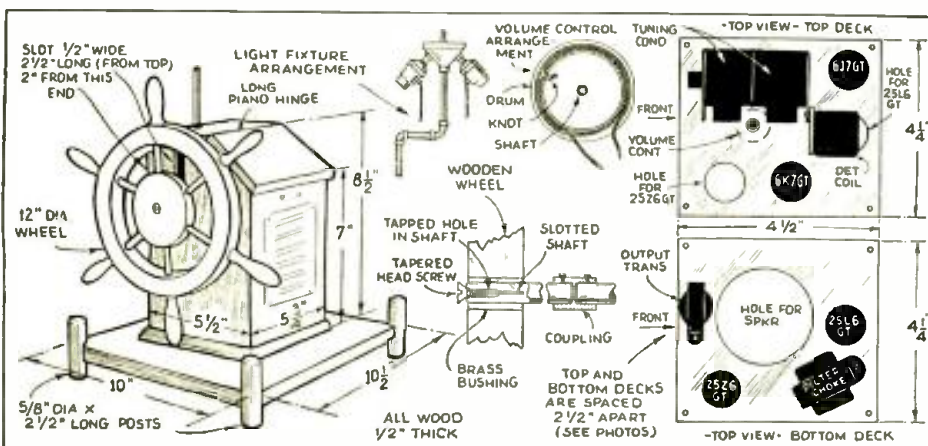

Fig. 3. Details for the lamp, volume-control drum and chassis.

You'll MAKE MORE TESTS

- Get **GREATER ACCURACY**
- and **STILL SAVE MONEY**

with these 2 NEW SENSATIONAL DEPENDABLE INSTRUMENTS



MODEL 432 - TROUBLE SHOOTER

• Handy pocket size D'Arsonval 0-1 milliammeter, accurate within 2%. Complete with self-contained batteries, ready

to operate. Low ohm range measures fractions of an ohm—a feature available only in higher priced testers. No test leads required for balancing ohmmeter.

- DC volts 0-5, 0-50, 0-500, 0-1,000.
- DC milliamperes 0-1, 0-10.
- Ohms 0-500, 0-50,000, 0-500,000.

Only **\$5.95**

MODEL 444 AC-DC MULTITESTER



• Complete self-contained AC-DC tester with 3 1/2" D'Arsonval meter, including DB meter and ohmmeter. Low ohm scale reads to less than 1/10 ohm.

- DC volts 0-5, 0-50, 0-500, 0-1000.
- DC Milliammeter 0-1, 0-10, 0-100.
- AC volts 0-5, 0-50, 0-500, 0-1000.
- Output meter same as AC voltmeter.
- Ohmmeter 0-100, 0-5000, 0-500,000.
- DB meter -12—+8, 8—28, 28—48, 48—54.

Only **\$9.95**

Write to Dept. C for Catalog



FREE

..tells how to



SAVE MONEY ON EVERYTHING YOU BUY!

.. NOW READY—big new Bargain Bulletin. Describes, pictures hundreds of amazing values. Tell us where to RUSH your FREE COPY:—

YOU can save many Dollars on your purchases out of this new Bargain Bulletin—on Radio Sets and Parts, Sporting Goods, Watches, Clocks, Cameras, Typewriters, Electrical Specialties, Novelties, and scores of other articles. Thousands of smart buyers have discovered this sure way to save money on standard, highest quality merchandise. You get prompt, courteous service, complete reliability. Get PROOF of big savings—take your pick of the amazing values shown to fill your present needs.

YOUR FREE BARGAIN BULLETIN IS WAITING Fill in and mail NOW the coupon below—or send postal or letter. No obligation. Some bargain offers limited—rush your request while stocks are at their best.

RADIO CIRCULAR CO., Inc.
 915 Broadway (Dept. R.C.), New York, N. Y.

MAIL THIS COUPON NOW

RADIO CIRCULAR CO. (Dept. R.C.)
 Yes, Rush my Free Bargain Bulletin.
 No obligation to me.

NAME

ST. & NO.

CITY & STATE

ANNUAL AWARDS by the I.R.E. last month went to fortunate recipients as follows: Medal of Honor, Dr. J. H. Dellinger, U. S. Bureau of Standards, for discoveries in wave propagation, and contributions to world-wide cooperation in telecommunications; Morris Liebmann Memorial prize (money and a scroll), G. C. Southworth,

Bell Labs., for his theoretical and experimental work in connection with ultra-H.F. wave propagation through dielectrics (wood, air, etc.), instead of through conductors (wire, etc.); and, \$1000, to A. L. Samuel, also of Bell Labs., for a paper on a novel vacuum tube for ultra-high frequencies. (Other I.R.E. news on page 189.)

Please Say That You Saw It in RADIO-CRAFT

READING 'RITING 'RITHMETIC . . . AND RADIO

(Continued from page 146)

sets of broadcasts are now presented—one for elementary school and the other for high-school level. Pupils, selected from competitive auditions, appear before the "mike" and there is no dearth of candidates for the programs.

Scripts are generally written by teachers—but whenever feasible, pupils are invited to submit their own. Some 60 elementary schools and 27 high schools are cooperating in the classroom broadcasts.

The broadcasts represent the first attempt to present an integrated school radio program. The programs are intended for classroom use, offered as supplementary aids to the teacher with the hope that they will furnish inspirational impetus in a variety of subjects.

One of the problems encountered is that not all of the schools have radio receiving sets at present. However, all of the new buildings are wired for radio, while many of the older ones have had radio sets installed or are getting them. In time, it is believed, every classroom in the entire New York Public School system will have its own radio!

The success of the broadcasts, says Dr. Benjamin B. Greenberg, assistant superintendent representing the elementary division declared, may have profound influence upon the future use of radio as an aid to education—and consequently, upon radio and P.A. sales and service in every town of reasonable size.

A 3-year study on "Radio and the Class-

room," made public recently by Miss Margaret Harrison, radio consultant for the Progressive Education Association, disclosed that the range of subjects open to the school increased through certain kinds of broadcasting.

Six weekly series of programs included: "Music of the Nations", the Elementary School Division; a feature, "Foreign Corners in New York"; "Speech and Personality"; "Imaginary Interviews with Great Literary Personalities"; "Accent on Living—America." The high-school topics cover a wide range of subjects; classroom discussions on science, art, music of nations, literature and current events, as well as dramatic presentations have been offered. Stuyvesant High School was on the air in June with a forum for Science classes on new developments in science being worked-on by high-school students.

Extension of the use of radio in the classroom grew out of an experiment conducted by the school system only last Fall, when Dr. Harold G. Campbell, Superintendent of Schools, authorized 7 radio broadcasts on the secondary level. These were voted a success with the result that the authorities have cooperated to extend the local SCHOOL OF THE AIR.

In charge of the Brooklyn Tech studio is Howard E. Shaw, coordinator of radio programs for the Board of Education and Radio Director at the High School; Production Assistant and Engineer are James MacAndrew and Herman Haeverkamp, respectively.

Size of box: 12 1/2" x 8 1/2"

\$2.75

Shipping Wt. 3 lbs.

VOGUE Pyro Pantagraph

With this PYRO PANTAGRAPH turn leisure time into profitable hours. Make money a novel, easy way—"Burn Your Way to Extra Dollars with Pyro Pantagraph." This electrical outfit is especially designed for burning designs permanently on Leather, Wood, Cork, Gourds, Bakelite, etc. Simply plug the Pyro-electric pencil in any 110-volt AC or DC outlet and it is ready to be used. Plug and cord furnished as part of equipment.

By the use of a special Pantagraph included in the outfit, any design may be reproduced either in original, reduced or enlarged form.

Outfit consists of: one Pyro-electric Pencil; one Pantagraph; three hardwood plaques; one bottle of Varnish; one Brush; one tracing tip and four-page instruction sheet.

Outfit will be forwarded by Express Collect if not sufficient postage included with your order.

WELLWORTH TRADING COMPANY

558 W. WASHINGTON BLVD., Dept. RC-9, Chicago, Ill.

PATENTS—TRADE MARKS

All cases submitted given personal attention by members of the firm.

Form "Evidence of Conception" with instructions for use and "Schedule of Government and Attorneys Fees"—Free

LANCASTER, ALLWINE & ROMMEL
PATENT LAW OFFICES

436 Bowen Bldg. Washington, D. C.

RADIO IN ITS ENTIRETY!

"B-A" serves the trade with every need in radio—complete 160-page catalog of nationally known radio receivers, public address, parts, supplies and equipment. Orders shipped same day received.

COMPLETE CATALOG AVAILABLE

BURSTEIN-APPLEBEE CO. 1812-14 MCGEE ST. KANSAS CITY, MO.

RADIO COURSES

RADIO OPERATING: Prepare for Gov't License Exam. ● RADIO SERVICING: Including Short Wave ● AMATEUR CODE ● ELECTRONICS ● TELEVISION ●

Day and Evening Classes—Booklet Upon Request

New York YMCA Schools

4 W. 64th Street, New York City

WHEN YOU THINK OF AMPLIFIERS

MEMBERS TO SEND FOR FREE 1938 P. A. CATALOG of Amplifiers Designed by A. E. Shaver

AMPLIFIER CO. OF AMERICA
37-47 West 20th St., New York, N. Y.

RADIO ENGINEERING

RCA Institutes offer an intensive course of high standard embracing all phases of Radio and Television. Practical training with modern equipment at New York and Chicago schools. Also specialized courses and Home Study Courses under "No obligation" plan. Catalog Dept. RT-38.

RCA INSTITUTES, Inc.

A Radio Corporation of America Service
75 Varlek St., New York 1154 Merchandise Mart, Chicago

SERVICING QUESTIONS & ANSWERS

(Continued from page 150)

tubes test OK. I have checked all resistors and condensers—none defective. When set is turned on, plate and screen-grid voltages are slightly higher than they should be. But there is no plate current on any of the tubes. Grid bias voltages seem to be normal.

After being turned on several minutes—sometimes hours—the set suddenly begins to operate normally. Sometimes it will "play" when turned on and after allowing it time to warm up. What can be wrong with it?

(A.) When the receiver in question is found in an inoperative condition, turn the receiver off by disconnecting the line plug, and check for continuity between cathode of each tube socket and each plate of the rectifier tube socket. Failure to obtain an indication in any tube cathode circuit should disclose your difficulty, which appears to be an "intermittent" resistor or lead.

INTERMITTENT OSCILLATION

(79) B. S. Byers, Ironton, Ohio.

(Q.) I have on hand a Gloritone 26. This set is troubled with intermittent oscillation. If you have anything in your files concerning this trouble please inform me or let me know of any ideas you may have about the matter. All voltages OK; most condensers have been replaced.

(A.) Intermittent oscillation on the Gloritone model 26 receiver is usually caused by open-circuiting screen-grid and cathode bypass (0.25-mf.) condensers. These condensers are located in a block under the transformer shields. Leads from the condensers serve as common leads to screen-grid and cathode circuits of tubes.

NOISY AT HIGH VOLUMES

(80) J. K. Exley, Van, Pa.

(Q.) Please tell me what to do for a United Motors 6-V. model R6015 receiver, which works OK on high-power stations or close stations but is noisy on all 3 bands when the volume is turned up. When the aerial and ground are disconnected it is very noisy on all 3 bands when volume is turned up.

(A.) From the symptoms described in your letter concerning United Motors 6-V. receiver, it appears that vibrator replacement is in order.

After replacing vibrator but before operating, check filter condensers for excessive leakage.

SET IS "DEAD"

(81) Pat Ruggles, Binghamton, N. Y.

(Q.) I have a Sparton model 301 A.C. which is "dead." I have tested all or practically everything and so far it has not worked. I put in a new filter condenser and made a continuity test on all circuits, but it still is dead. Tubes are all OK. The set when turned on functions, speaker is aligned and has a slight hum, but cannot receive any signal at all. Kindly advise as to what you think I should do to make this set work.

(A.) From the information given in your letter, it would appear that the power output tubes' grid-bias resistor is open-circuited. Check this by removing each tube in turn after receiver has been set up for operation. A click should be heard as each power tube is removed, and again when re-inserted. This resistor should be replaced with a 900-ohm, 10-W. wire-wound unit.

FADING

(82) George W. Weaver, Saxton, Pa.

(Q.) I have a set in for repairs. The set is a Silvertone 330 superheterodyne series No. 501-057, 5-tube A.C., broadcast band 540-1,700 kc. Tubes used: 1—80, 2—57's, 1—47, and 1—58.

The trouble is fading, and sometimes it will cut clear off and come back on again. The portion of the dial from 700 kc. to 540 kc. seems unable to receive any stations, but if I remove the wire from the oscillator and detector tube, that is the screen-grid lead from the 57 tube, and put it back on again stations come in with good volume on this portion of the dial. This lasts for an evening or two; then the same trouble.

Voltages and everything seem to check OK.

(A.) Most likely the trouble described is due to a defect in the cathode circuit of the 57 1st-detector—oscillator tube. No data or diagram for this receiver is available.

Check the 1st-det.—osc. cathode bias resistor carefully, as well as its associated bypass condenser. Should these prove intact, then either increase the plate voltage or value of the cathode-bias resistor in this stage.

Please Say That You Saw It in RADIO-CRAFT

THE PRINCIPLES OF NOISE-REDUCING ANTENNA SYSTEMS

(Continued from page 157)

the use of a system, substantially like the circuit of Fig. 4.

Two methods are used: In one, an artificial antenna is successively connected to a calibrated radio set—first by an open downlead wire and second by means of the noise-reducing system.

A signal from a microvolter is impressed and the difference in the input voltage level (in db.) is obtained, which gives the gain or loss of signal strength by the use of the system.

Then, a source of interference is introduced in various ways imitating the manner in which it enters in actual practice. The level difference is measured again and thusly the ability to reduce noise is obtained. It is expressed also in db.

Two curves are plotted with frequency as abscissa and db. as ordinates; one for signal gain and the other for noise reduction. The algebraic sum of the ordinates of the 2 curves gives the "advantage" in db., that is, the actual gain in quietness of reception that can be secured by the use of the system.

In the second method an actual antenna is used, with actual signals, instead of the dummy antenna and signal generator.

Interference is produced, for example, by means of a Shelton Violet-Ray Vibrator and by means of a multipole switch at the aerial, controlled by a pull string or by other remote control devices, changes the antenna from a straight "T" with open downlead to a noise-reducing system.

The results of both methods agree in the majority of tests within the experimental error.

IS NOISE ACTUALLY REDUCED?

As an example of the tests above described, the 3 graphs in Fig. 5 are given. Line A represents signal gain or loss by the use of a noise-reducing system of substantially the same circuit as Fig. 4. Line B is the noise reduction and line C is the algebraic sum of A and B. For example: At 1,000 kc. there is a signal gain of 3 db., a noise reduction of 7 db. and, therefore, an "advantage" of 3 + 7 db. as shown in line C. At 800 kc. we lose 1 db. signal strength but we eliminate 18 db. of noise, hence the advantage is 18 - 1 = 17 db., as given by line C.

CAN YOU PROPERLY INSTALL NOISE-REDUCING ANTENNAS?

In practice one of these two features may be omitted for commercial reasons and then the system will be only a partial noise-reducing circuit, such as Fig. 6. For example: The doublet being omitted, the wire AA' of Fig. 4 will act as a "T" antenna for shortwaves also. Then it is necessary to use 2 transformers with frequency-selecting condensers as in Fig. 6, or one only, having a very broad frequency band of satisfactory performance. An iron core will be indispensable here, so as to reduce the leakage reactance and distributed capacities, in order to permit somewhat satisfactory operation between, say, 500 and 20,000 kc.

In another instance, the local ground may be hard to find. Then the transmission line itself may serve as ground connection by actually grounding the midpoint to the chassis, Fig. 7 of the set, and returning the wire x of Fig. 4 to the midpoint Y, of the secondary S' instead of to the local ground! Here the noise reduction in the broadcast band is only partial, because there will be

a metallic path for interference currents, as E2 in Figs. 2 and 3 up to the antenna, and by virtue of their passage through P' to the antenna, develop a voltage across S', which will be transferred back to the radio set by the line TL and transformer PS.

In this scheme, however, the grounding of the midpoint Y to a large metallic surface near the antenna transformer will help enormously to reduce the noise by diverting the currents away from P'!

Hence, when noise-reducing antenna kits are installed and they do not call for a roof-ground (using the metallic roof-top) connection, a considerable improvement in signal-to-noise ratio will be noticeable by grounding the line at the roof, particularly in metropolitan areas and in buildings with elevators, buzzers, etc., and more so where D.C. is used instead of 60 cycles for power.

Where this is done, the radio set should preferably be equipped with a receiver coupler having no metallic connection between primary and secondary. There are a few very good receiver couplers of this type on the market.

Figure 8 shows the signal gain, noise loss and advantage (all in db.) of a system containing the receiver coupler above mentioned when compared with a straight "T" antenna of the same dimensions (30 x 30 ft. flat-top as "T" or 30 x 30 ft. doublet with system).

From inspection of line C, it is apparent that the average advantage is about 25 db.

From the preceding examples, it is easy to see that with the knowledge of the fundamental principles and a little imagination, much improvement can result, even when total noise reduction in all bands is not economically feasible. There has been no standard testing circuit or even a figure of merit, or at least definite specifications for performance of modern all-wave receiving antenna systems.

An effort along these lines is being made now by The Radio Club of America to standardize both the specifications and the circuit to measure noise reduction, as it may be seen in a recent paper delivered before The R. C. of A. on May 12, 1938.

When better standards are officially adopted by the I.R.E. or the R.M.A., the fake systems will rapidly pass out of existence and the advantages enumerated in this article by the noise-reducing circuits will be fully appreciated.

This article has been prepared from data supplied by courtesy of Amy, Aceves & King, Inc.

BUSTAN—News Item

The Bureau of Standards announced last month, at the joint meeting of the International Scientific Radio Union and the I.R.E. in Washington, D. C., that facilities are now available in the Bureau for testing microphones through a frequency range of 100 to 10,000 cycles. Measurements are made with a Rayleigh disc in a 16 x 16 x 12 ft. high, soundproofed room.

"Heavy water" has been found applicable in maintaining certain standards that engineers use as paving blocks for each forward step. This "deuterium oxide" is used by Bureau of Standards engineers Brickwedde and Vinal, in place of "ordinary" water in Weston-type cells employed as standards for the volt.

Please Say That You Saw It in RADIO-CRAFT

You'll LEARN EASIER . . . MAKE MONEY FASTER with SPRAYBERRY'S PERSONAL HOME TRAINING IN RADIO!

Actually Sets You Up for Business

Be your own Boss! Get into the fast moving Radio industry. If you are an ambitious fellow, I can train you for a good paying full time or part time job with a big future ahead. My training is distinctly new and different.

Television Covered . . . Earn While You Learn

Sprayberry Training not only covers thoroughly all phases and branches of Radio. It equips you for an actual start in business. I show you how to get profitable spare time Radio service work. Moreover, I show you how to do these jobs. You gain practical experience . . . add easy cash to your bank account while learning.

BIG PROFESSIONAL OUTFIT GIVEN! Consists of All-Wave, All-Purpose Analyzer, Rider Manuals (7,078 pages), Tool Kit, Electric Eye Outfit, Experimental Apparatus. THE SPRAYBERRY COURSE IS SOLD UNDER AN IRONCLAD MONEY-BACK AGREEMENT.

A. H. Lanole, Northbridge, Mass., writes: "Since enrolling I have cleared a net profit of more than \$150. in spare time alone. and I am not half through the Course yet. Honestly, I cannot understand how you give so much dope for so little money!"

SPECIAL SERVICEMAN'S COURSE Advanced Training for those already in Radio—teaches the easiest way to do the hardest jobs. Complete details of this advanced course and fundamental course, features, etc., fully described in my 48 page FREE book. Send for your copy today.

Mail Coupon Now

SPRAYBERRY ACADEMY OF RADIO
L. Sprayberry, Pres.
120-J University Place, N.W.
Washington, D. C.

Please send me FREE copy of "More Money in Radio"

Name Age

Address

City State

Mail in envelope or paste coupon on postcard.

SETTING THE PACE

CORNELL-DUBILIER TYPE "BR"

Ultra-compact, unexcelled for all types of service and experimental work. Far ahead in advanced design—outstanding electrical characteristics—and inherent dependability. Equipped with special vent. Easy to wire-in. These tiny "Blue Reaver" electrolytics are typical of Cornell-Dubilier's complete line of capacitors for every radio application. C-D sets the pace for capacitor performance and dependability!

COPIED - IMITATED
But Never Duplicated!
Demand the original Type BR etched foil electrolytic. Product of the world's oldest and largest manufacturer of capacitors.

FREE
A real house organ for the radio technician! Get your copy of the "C-D Condenser" regularly by mailing the coupon below.

CORNELL-DUBILIER ELECTRIC CORP.
1014 Hamilton Blvd., So. Plainfield, N. J.

Rush copy of the last issue of the "C-D Condenser". Also place me on your mailing list.

MAIL NOW

Name

Address

City State

LOOK, MR. SERVICEMAN!

- ★ CHAPTERS in 40 CITIES
- ★ MEMBERS in EVERY STATE
- ★ and in ALL PARTS of the WORLD

—That's the Record of the RSA
in only 6 Months!

More and more, Servicemen have come to realize that it pays to belong—that the RSA is the one big constructive and progressive organization of Servicemen for Servicemen—that it is genuinely and actively helping every member.

YOU GET ALL THIS

(Material and Service that's Worth \$75 and More)

YOU become eligible for participation in the Advanced Extension Course for Professional Servicemen—available to RSA Members only. ☆ YOU GET monthly Advertising and Business Promotion ideas to increase your business and make it more profitable. ☆ YOU GET a subscription to "The Radio Serviceman"—the Association's monthly magazine. ☆ YOU GET the benefits of being included as a "REGISTERED AND QUALIFIED SERVICEMAN" on record at National Headquarters for reference. ☆ YOU GET a Certificate of Merit to hang in your shop. ☆ YOU GET a pocket card of credentials. ☆ YOU GET the assistance of our big expert technical staff as a department in your service business. We will give you the RIGHT answer to your "impossible" service problems. ☆ YOU GET (if you belong to a local servicemen's group) access to our National Speakers' Bureau—famous speakers for your meetings. ☆ YOU GET advance technical information on new circuits.

☆ It's as important to you as your job or your business! JOIN NOW and get in on all its benefits.

RADIO SERVICEMEN OF AMERICA, Inc.

Joe Marty, Jr., Executive Sec'y, 304 S. Dearborn St., Chicago

MAIL THIS COUPON

RADIO SERVICEMEN OF AMERICA, INC. R-9
304 South Dearborn St., Chicago, Ill.

Gentlemen:

I hereby make application for membership in the Radio Servicemen of America.

Name

Home Address

City State

Firm Name

Address

..... I am enclosing \$2.00 National Yearly Dues
(Plus Nominal Local Chapter Dues)

..... Bill me \$2.00 National Yearly Dues

THE LATEST RADIO EQUIPMENT

(Continued from page 162)

improved electrodynamic speaker equipped with dust screen, and beam power output. Tuning range of 540-1,720 kc. includes domestic broadcasts and police calls. Measures 5 1/4 x 7 1/2 x 4 7/16 ins. deep.

The new receiver line, of which the 9X is an inexpensive model, includes 38 types designed to fit every modern need in the home and in the automobile.

6V. D.C. OR 110V. A.C. PORTABLE SOUND SYSTEM (1670) (Wholesale Radio Service Co., Inc.)

A FEATURE of this 20- to 30-W. (on either power supply) sound system is a phono turntable with built-in motor for use on both types of current!; both 10- and 12-in. records may be accommodated. This phono turntable is an available attachment to the amplifier. A crystal pickup is used.

The amplifier has 3 inputs, 1 high-gain and 2 low-gain with built-in electronic mixer-fader controls for blending both low-gain inputs, or either low-gain input with the high-gain channel. A fully variable wide-range tone control permits accurate adjustment for acoustical compensation.

400-CYCLE OUTPUT FILTER (1671) (Philco Radio & Television Corp.)

STRONG external noises or broadcast signals which interfere with the output meter signal when aligning sets no longer need trouble the Serviceman. A new 400-cycle output filter developed for use in the laboratories by the engineers of one manufacturer is now available for aligning work.

This new filter might be called a "screen-grid eliminator" because it does just that. The unit is connected between the plate or plates of the output tubes and the output meter by means of socket pin clips. Its action is such as to block all signals going into the output meter except 400 cycles, which is the modulation frequency of most signal generators.

14-TUBE, 60-WATT SOUND SYSTEM INDICATORS (1672)

(The Webster Co.—Chicago)

THIS 14-tube Public-Address system incorporates a number of new features including high-speed expander, multi-stage degeneration, remote control and dual tone compensation. The flexibility of this equipment makes it particularly adaptable to high-quality reproduction under trying conditions and is especially suitable to outdoor applications—such as ball parks, stadiums, arenas, and amusement parks—for handling crowds in excess of 20,000 persons.

The amplifier is equipped with 4 input mixing circuits and has variable output connections. This "Webster-Chicago" system is furnished with 2 P.M. speakers and either velocity- or dynamic-type microphone.

BUREAU OF STANDARDS—

News Item

BUSTAN engineers Gilliland, Kirby, Smith and Reymer presented in May *Journal of Research*, according to *Technical News Bulletin* last month, graphs covering best wavelengths for various services during the rising-half of an 11-year sunspot period, or from 1933 to 1937. Inversely, it is suggested that the graphs present important reference data for use during the descending half-period from 1938 to 1944.

Please Say That You Saw It in RADIO-CRAFT

RADIO WITTIQUIZ

(Continued from page 159)

(127) A *variometer* is:

(a) A variable-range meter. (b) A volume control. (c) A current-saving meter on a refrigerator. (d) A radio tuning device consisting of a stator and rotor coil to vary the mutual inductance.

FRANK PONTONIO

(128) A *loading coil* is—

(a) Part of a machine gun. (b) A coil inserted in a circuit to increase the normal inductance. (c) A small coil in series with the voice coil on a dynamic speaker. (d) A coil whose resistance drop is used to supply grid bias.

(129) *Syntony* is—

(a) An elaborate composition for a full orchestra. (b) The harsh tone of a poor speaker. (c) The action which results from a push-pull circuit. (d) The condition of 2 oscillatory circuits having the same frequency.

W. G. BRETZ,
Ontario, Canada

(130) *Photoelectric cells* are usually—

(a) Employed to take photographs by the aid of electricity. (b) Employed to amplify the light aimed at it. (c) Employed to indicate or measure changes in the intensity of the light coming from a source. (d) Employed in sound picture work.

(131) *Weighing circuits* are—

(a) Circuits that have weight because so much lead was used to draw them. (b) The radio circuits used in special instruments used for the purpose of weighing articles. (c) Circuits in a radio receiver that have weight.

WENDEL CALKINS

(132) A *backwave* is—

(a) A radio wave repelled by the antenna of a receiver. (b) A wave caused by the reverse in direction of the forward motion of a wave train. (c) A signal which is heard from a telegraph transmitter with the key open. (d) A flipping motion of the hand from the rear.

(133) A *keeper* is—

(a) A doughnut-shaped coil, with the field concentrated within the coil. (b) a box containing apparatus for starting motors. (c) The piece of iron used to close the magnetic circuit of a permanent magnet to prevent loss in magnetic strength.

MERLIN J. DASTE

(134) Do you believe that *heater current* is—

(a) Current used in a radio set to warm it? (b) The flow of electrons in an electric heater? (c) The Gulf Stream in the Atlantic Ocean? (d) The current flowing through the cathode heating element of a radio tube?

(135) Everyone knows *cross talk* is—

(a) The alternate slamming of Fred Allen and Jack Benny of radio notoriety. (b) Result of 2 bare wires crossed and touching each other in a radio set. (c) Two stations interfering with each other on your radio receiver. (d) The type of controversy "radio wives" indulge in when their husbands are experimenting with a radio. (e) Speech or sounds in one telephone or radio circuit carried into another circuit by electromagnetic or electrostatic induction between the conductors.

(136) A *bucking coil* is—

(a) A radio coil that refuses to carry signals. (b) An induction coil or winding so connected that its field opposes the field of another winding, their polarities being opposite. (c) A special rope used by cowboys in roping broncos on the range. (d) A coil used to eliminate undesired signals in a radio set.

(137) We all know a *cathode ray* is—

(a) An ultra-violet ray from the sun during summer months. (b) A ray of light radiating from the cathode of a radio tube. (c) A stream of electrons emitted from a cathode. (d) Heat radiated from a radio tube.

(138) A *knife switch* is—

(a) A switch in which one contact is formed by a flat metal blade and the other by a piece or pieces of metal with which the blade makes contact. (b) When 2 boys trade pocket knives. (c) A radio switch made from a knife. (d) A switch, that is very fine and sharp, used in a radio receiver or transmitter.

W. R. BLACKSHAW,
Ontario, Canada

(139) A *cation* is—

(a) The right eye of a cat. (b) An electropositive ion. (c) An electronegative ion. (d) The filament of a vacuum tube.

(140) A *lightning arrester* is—

(a) A fast policeman. (b) A device to keep the antenna shorted. (c) A device to protect electrical apparatus from lightning and atmospheric discharges. (d) A device used to keep lightning from striking an antenna.

ROBERT HYMAN

ANSWERS

(117c)	(118c)	(119d)	(120b)	(121c)
(122b)	(123c)	(124c)	(125d)	(126b)
(127d)	(128b)	(129d)	(130c)	(131b)
(132c)	(133c)	(134d)	(135e)	(136b)
(137c)	(138a)	(139b)	(140c)	

CONTEST RULES

(1) An award of a 1-year subscription to *Radio-Craft* will be given, each month, to each person who submits one or more WITTIQUIZZES that the Editors consider suitable for publication in *Radio-Craft*.

(2) WITTIQUIZZES should preferably be typed; use only one side of paper.

(3) Submit as many WITTIQUIZZES as you care to—the more you submit the more chance you have of winning—but each should be good.

(4) Each WITTIQUIZ must incorporate humorous elements, and must be based on some term used in radio, public address or electronics. Each WITTIQUIZ may have 4 "answers," only one of which of course will be correct; and, only 1 of which is non-radio.

(5) All answers must be grouped, by question number and correct-answer letter, on a separate sheet of paper.

(6) All contributions become the property of *Radio-Craft*. No contributions can be returned.

(7) This contest is not open to *Radio-Craft* employees or their relatives.

Please Say That You Saw It in RADIO-CRAFT

CINAUDAGRAPH

Speaker



CINAUDAGRAPH

Permanent Magnet Speakers

used extensively by all leading radio receiver and P. A. equipment manufacturers—are available in a complete size range from 5 to 18 inches.

For simplicity of installation—dependable service and complete customer satisfaction—standardize on Cinaudagraph speakers. Carried in stock by all progressive distributors. Complete descriptive literature on request.

Newline of electro-dynamics from 5 to 10 inches.



CINAUDAGRAPH CORPORATION

Speaker Division • Stamford, Conn.

WHAT'S IT TO YOU

... that 8 years ago Service Engineers started to climb on NATIONAL UNION'S BAND WAGON?

What's it to you? Just this. Today, as then, National Union gives first consideration to the needs of the Radio Service profession ... studies your problems ... does something practical about it.

Think of it! More than one hundred thousand pieces of necessary shop equipment have been given to Service Engineers during these eight years. The men who are riding the N.U. band wagon have year after year, cashed in on the National Union policies listed below.

FREE EQUIPMENT FOR THOSE WHO BUY N.U. TUBES AND CONDENSERS.

QUALITY PRODUCTS GUARANTEED TO INSURE CUSTOMER GOOD-WILL

FAIR PROFIT MARGINS.

PRICE MAINTENANCE BY REFUSAL TO SOLICIT CUT RATE OUTLETS.

FREE SALES HELPS AND BUSINESS FORMS CREATED TO SELL SERVICE.

WANT TO EXPERIMENT WITH TELEVISION?

You can build your own transmitter and receiver! Ask your N.U. jobber about N.U. Television tube types and free circuit information.

NATIONAL UNION RADIO CORPORATION
57 State St., Newark, N. J. RC-938

Who is my nearest N.U. Distributor?

Name

Street

City State



↑
**THIS
SHADE
TILTS
UP AND
DOWN**

**This MODERN DESK LAMP
Is Yours Absolutely FREE
With a Year's Subscription to RADIO-CRAFT**

JUST THINK OF IT—you can get absolutely FREE, the beautiful desk lamp shown at the left. This attractive desk lamp is suitable for home, desk, den, office, laboratory, studio or workshop. It is sent to you by the publishers with their compliments for a one-year subscription to RADIO-CRAFT. Look at the many fine features which this handsome desk lamp has. Read the list below.

LOOK AT THESE FEATURES!

- ⊗ Constructed of metal with attractive bronze finish.
- ⊗ Scientifically constructed to give glareless, diffused light.
- ⊗ Helmet-type shade can be tilted to any convenient angle.
- ⊗ Stands 13" high and has 10" metal shade.
- ⊗ 5-foot rubber insulated cord and plug.
- ⊗ Constructed to last for many years.

Clip Coupon Today — and Mail!

Send your subscription today to RADIO-CRAFT for One Year (12 issues) and receive absolutely FREE one of these truly remarkable desk lamps. New subscribers are accepted or you may extend your present subscription another twelve months under this offer. Mail your remittance of \$2.50 (Plus 25c for shipping charges on lamp) to the publishers of RADIO-CRAFT. (Canada and foreign \$3.25) You will promptly receive your FREE DESK LAMP by return mail. Use the coupon at the left to order your subscription.

RADIO-CRAFT ⊗ 99 HUDSON STREET ⊗ NEW YORK, N. Y.

Gentlemen: Enclosed you will find my remittance of \$2.50 for which enter my subscription to RADIO-CRAFT for One Year (12 issues). Send me promptly my FREE DESK LAMP. (Canada and foreign \$3.25) In U. S. add 25c additional to cover shipping charges on lamp.

() NEW SUBSCRIBER () EXTEND PRESENT SUBSCRIPTION

Name

Address

City State

(Send remittance by check, money order or unused U. S. Postage stamps. Register letter if you send cash or stamps.)

RC-938

RADIO-CRAFT ⊗ 99 Hudson St. ⊗ NEW YORK, N. Y.

HIGH-FIDELITY GOES TO TOWN

(Continued from page 154)

drivers. Resistance-capacity coupling is employed throughout this system.

SENSITIVITY

Over-all gain in the HF-1 is purposely limited to approximately 100 microvolts for 1 watt of output. It is, therefore, not considered a DX receiver. High sensitivity is avoided so as (1) to reduce hiss and noise associated with highly-sensitive receivers

with wide I.F. acceptance; (2) to limit the number of receiving stations to those of high field strength; and, (3) to preclude the reproduction of low-frequency flutter and howl resulting from simultaneous reception of 2 carriers, having comparable field strengths, assigned to the same channel but which differ slightly in frequency.

SELECTIVITY

Since increased fidelity cannot be obtained without decreased selectivity or increased I.F. band-width, suitable transformers are used, and a switch is employed for varying the selectivity of the I.F. system to "Broad", "Medium", and "Sharp" response. (See Fig. 2.) Adjacent (10 kc.)-channel attenuation is respectively varied from about 27/1 to 1,000/1 enabling the user to operate the receiver under a greater variety of conditions. In the Sharp position of the control, the high-frequency response of the audio system is further reduced by shunting a 0.01-mf. condenser from the 1st audio stage plate to chassis.

Selectivity change is accomplished by use of 2 transformers between the mixer stage and 1st I.F. grid; the 2 interconnected through a circuit which permits variation from an under-coupled to an over-coupled condition. (See Fig. 1A.)

DISTORTION

The fact that the receiver can reproduce faithfully in the upper-frequency range, which includes harmonics produced by distortion, necessitates a more stringent standard on distortion content. Correct loading characteristics on the detector diode system is therefore provided for low distortion at high percentages of signal modulation. The distortion occurring in the audio

system is maintained well below 2% at normal output levels. Inversed-feedback amounting to about 9 db. at 400 cycles, corrects low-frequency "hangover" effects due to loudspeaker resonance, minimizes distortion, and suppresses residual hum level. (See Fig. 1B.)

OSCILLATOR STABILITY

Oscillator stability is controlled by a specially-constructed condenser, the value of which varies by a predetermined amount with temperature changes. The change in fixed capacity is opposite in direction to variation of stray circuit capacity, and the combined effect of temperature is practically nil.

Stability is maintained to an accuracy approaching 0.15-kc. per degree temperature change between the limits 30° C and 60° C. Service replacements of the compensator condensers should always be of the type supplied by the manufacturer. (See Fig. 1C.)

(The frequency range of this receiver, with its pushbutton selection of 8 stations, is 540 to 1,550 kc. [which includes the 4 special high-fidelity stations].—Editor)

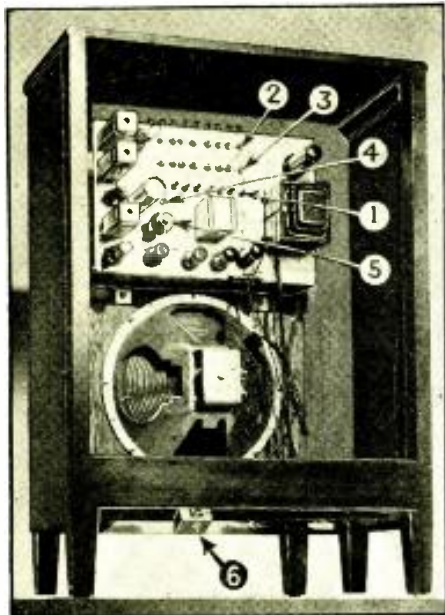
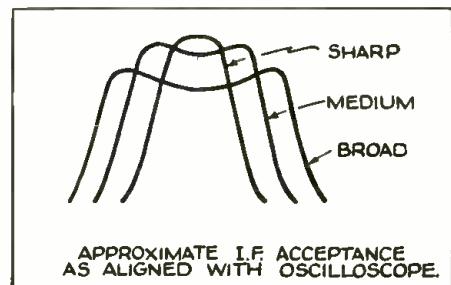

Fig. B. Rear view of HF-1. Numbers refer as follows: (1) magnetite-core osc. screws; (2) link-circuit trimmers; (3) ant. trimmers; (4) phono jack; (5) removable, aligning "Magic Eye" tube; (6) pilot light.



APPROXIMATE I.F. ACCEPTANCE AS ALIGNED WITH OSCILLOSCOPE.

Fig. 2.

Please Say That You Saw It in RADIO-CRAFT

NEW SET-UP FOR PRACTICING CODE

(Continued from page 159)

at it or hearing it, speed can be quickly increased by several methods. The author increased his speed very rapidly by walking through the streets and reading, in code, the advertisements on the billboards. It is very interesting and fascinating when there are more than 2 students together to see who can read advertising names faster in code. the letters being repeated aloud.

A still better method of learning the code is to be able to see and hear virtually at the same time what is being sent or received as follows.

There is on the market an economical motor-driven recorder which connects to any standard radio receiver; code signals tuned-in are then automatically recorded on the tape, at code speeds from 100 words down to 2 words a minute (5 letters per word). Thus the beginner can receive amateur or commercial code from the air, and by copying the code he can instantly check on the letters with which he is having difficulty; then by observing the letters on the paper tape he can instantly learn wherein the difficulty lies.

In addition, the operator can use the machine in conjunction with an audio oscillator or a battery and a transmitting key so that personal recordings can be made on the tape which will instantly indicate the direct nature of the transmitted code. By this means the dashes and dots can not only be corrected as to length but also the letters themselves and the arrange-

ment of the groupings can be immensely improved.

The oscillator, in addition, can be connected to the chassis and detector-tube grid of an ordinary radio receiver and the output will be heard on the loudspeaker. One type of oscillator specially designed for practicing code is shown in Fig. A. It develops enough audio energy in itself to operate a high-impedance loudspeaker; and variable tone is available from 500 to 5,000 cycles with the mere turn of the dial on the oscillator (which, incidentally, is available on the market). The circuit, which is shown in Fig. 1, is new.

There are 2 terminals where 5 milliamperes at 25 volts may be obtained for operating the key relay of a transmitter so that the amateur operator may listen to his keying as he transmits. In addition, this voltage may be also used for supplying marking voltage to the code reader for individual recordings.

Two terminals are also available for the key itself and the output terminals are connected directly to a high-impedance loudspeaker. Only one tube is used on the oscillator, a 12A7; and the unit works from 110-120 volts, A.C. (any cycle) or D.C.

In the photo we see a "Y.L." (in ham-radio patois, "young lady") in the approved stance for manipulating the "sideswiper," or "cootie," which is the next thing to a "speed key." The speed key, in which dots are made automatically, should not be used by the radio beginner until he (or she!) is thoroughly expert on the Morse-type key, or at least, the sideswiper. Many code teachers prefer to start the tyro practicing code with a regular "Morse" key, the lever of which moves up-and-down, instead of the cootie type of key, shown here, in which the lever moves from side-to-side. However, we're tempted to curry favor with the fair sex by recommending the latter, in view of its lesser strain on finger muscles (which in Morse-key operation beginners are prone to use unduly) and greater use of the strong forearm muscles.

The radio operator can develop a real "personality" fist, not by attempting to acquire a trick swing, but by making every effort to send a "clean" signal,—that is, one in which dot and dash spacings, and word spacings, are uniform. In sending messages, the old adage to "make haste slowly" is recommended as the best policy to follow; try not for speed but ACCURACY—the former will automatically follow with practice.

This article has been prepared from data supplied by courtesy of American Communications Corp.

A	•—	S	•••
B	••••	T	—
C	—•••	U	••—
D	—••	V	•••—
E	•	W	••—•
F	••••	X	—•••
G	—•••	Y	—••—
H	••••	Z	—•••
I	••	1	•••••
J	•••••	2	•••••
K	•••••	3	•••••
L	•••••	4	•••••
M	•••••	5	•••••
N	•••••	6	•••••
O	•••••	7	•••••
P	•••••	8	•••••
Q	•••••	9	•••••
R	•••••	0	•••••

The Continental Code.

BRAIN RADIO

Brain waves were shown last month by Drs. Cohn and Langenstrass of St. Elizabeth's Hospital in Washington to pulse in direct-current beats of 10 to 30 minutes each through the human brain under the influence of insulin, injected to produce a comatose shock; the usual alternating-current waves from the same portion of the brain are simultaneously observable. As the *New York Times* reported it, "It was much as if a clock with a very fast tick were also equipped with a long pendulum which made one full swing to every 6,000 ticks."

This report to the American Psychiatric

Association was followed by another, also on brain waves, jointly by Dr. and Mrs. Davis, Harvard Medical School. The latter report showed that abnormal brain-wave patterns found in epileptics and types of psychotic patients could be reproduced in normal persons by lowering the oxygen supply or by other physiological changes.

Mrs. Davis also reported, individually, several instances in which unsuspected brain tumors, lesions or other pathological conditions had been revealed by the abnormal patterns of the patient's brain waves (as shown by an oscilloscope)—and confirmed by X-ray examination!

Please Say That You Saw It in RADIO-CRAFT

Setting New Standards for Midget Condenser Performance



(Etched Foil Dry Electrolytics)

SPRAGUE ATOMS

A whale of a lot better than you ever thought a small condenser could possibly be made—that, in brief, is the Sprague ATOM! They're better, in fact, than lots of other makes of condensers two or three times their size.

Sprague ATOMS are small enough to fit in anywhere—and believe us, they'll stand the gaff. They're made by an exclusive Sprague etched foil process that puts more real, honest-to-goodness quality per inch into a condenser than has ever been put there before. And don't worry about "blow-ups." There's not a "firecracker" in a car-load.

HERE'S WHERE YOU SAVE MONEY!

ATOMS are made in a complete line of capacitance and voltages including DUAL COMBINATIONS—just the thing for hundreds of inexpensive "duplicate" replacements. And they'll save you money! List price on the 8 mfd. 450 V. Atom is only 60c. Other capacities priced proportionately low. Sold singly by leading jobbers or in handy kits.

SPRAGUE
450 VOLTS

SPRAGUE
PRODUCTS CO.
North Adams, Mass.

The
HIT OF
THE
SHOW

TRIPLET
Simplified
PUSH-BUTTON
TESTING



Rotating Chart Shows Correct Button to Push

Mutual Conductance Per Cent Scale

MODEL 1616

ONLY \$73.34

DYNAMIC MUTUAL CONDUCTANCE
Tube Tester and Volt-Ohm-Milliammeter
Many Claim Dynamic Mutual Conductance...
Triplett Positively Has It.

The hit of the Radio Parts Trade Show was this pace setting push-button tester by Triplett, with its revolutionary advancements. After rotating chart to the tube to be tested, the button to push is clearly marked under each row. Furnished in attractive, all-metal case with lustrous finish. Removable cover for portable or counter use... sloping Panel. See It at Your Jobbers.

TRIPLET ELECTRICAL INSTRUMENT CO.
159 Harmon Dr., Bluffton, Ohio
Please send me more information on
—Model 1616
—Complete 8 pp. Two-Color Catalog

Name
Address
City State

FOUR NEW 10¢ RADIO BOOKS!

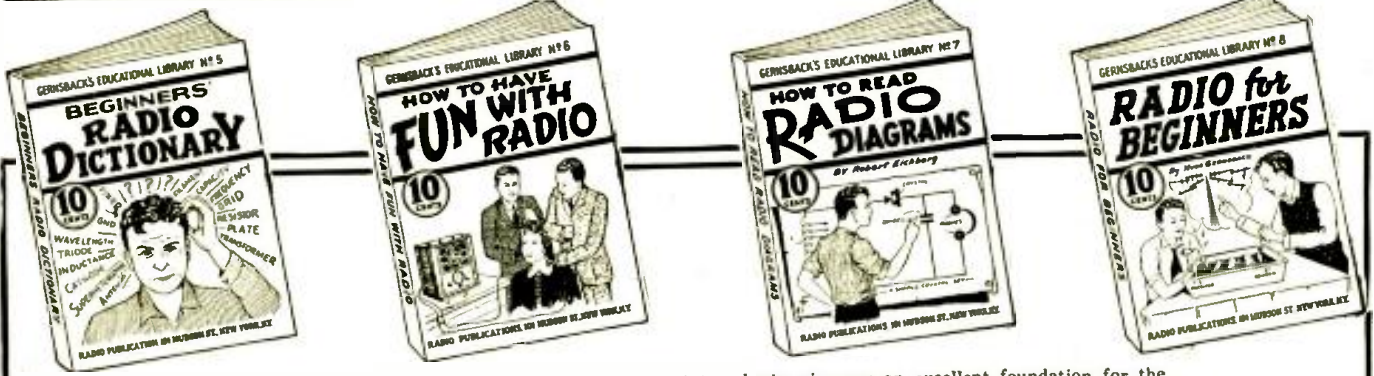

RADIO FANS EVERYWHERE—these little ten cent text books give you an excellent foundation for the study of radio. They are clearly written, profusely illustrated and contain over 15,000 words in each book. You'll be amazed at the wealth of information these volumes have. They are handy for review or reference books.

NO. 5—BEGINNERS' RADIO DICTIONARY

Are you puzzled by radio language? Can you define frequency? Kilocycle? Tetrode? Screen grid? Baffle? If you cannot define these very common radio words and dozens of other, more technical, terms used in all radio magazines and instruction books, you need this book in your library. It's as modern as tomorrow—right up to the minute. It tells you in simple language just what the words that puzzle you really mean. You cannot fully understand the articles you read unless you know what radio terms mean. This is the book that explains the meanings to you. Can you afford to be without it, even one day longer?

NO. 6—HOW TO HAVE FUN WITH RADIO

Stunts for parties, practical jokes, scientific experiments and other amusements which can be done with your radio set are explained in this fascinating volume. It tells how to make a newspaper talk—how to produce silent music for the deafened—how to make visible music—how to make a "silent radio" unit, usable by the deafened—how to make toys which dance to radio music—sixteen clever and amusing stunts in all. Any of these can be done by the novice, and most of them require no more equipment than can be found in the average home. Endless hours of added entertainment will be yours if you follow the instructions given in this lavishly illustrated book.

NO. 7—HOW TO READ RADIO DIAGRAMS

All of the symbols commonly used in radio diagrams are presented in this book, together with pictures of the apparatus they represent and explanations giving an easy method to memorize them. This book, by Robert Eichberg, the well-known radio writer and member of the editorial staff of RADIO-CRAFT magazine, also contains two dozen picture wiring diagrams and two dozen schematic diagrams of simple radio sets completely explained in language which is easily understood by the radio beginner. More advanced radio men will be interested in learning the derivation of diagrams, and the many other interesting facts which this book contains.

NO. 8—RADIO FOR BEGINNERS

Hugo Gernsback, the internationally famous radio pioneer, author and editor, whose magazines, **SHORT WAVE** & **TELEVISION** and **RADIO-CRAFT** are read by millions, scores another triumph with this new book. Any beginner who reads it will get a thorough ground work in radio theory, clearly explained in simple language and through the use of many illustrations. Analogies are used to make the mysteries of radio as clear as "2+2 is 4." It also contains diagrams and instructions for building simple radio sets, suitable for the novice. If you want to know how transmitters and receivers work, how radio waves traverse space, and other interesting facts about this modern means of communication, this is the book for you!

Other Titles in This 10c Book Series!

- No. 1—HOW TO BUILD 4 DOERLE SHORT-WAVE SETS
- No. 2—HOW TO MAKE THE MOST POPULAR ALL-WAVE 1- AND 2-TUBE RECEIVERS.
- No. 3—ALTERNATING CURRENT FOR BEGINNERS
- No. 4—ALL ABOUT AERIALS

Four other volumes in this ten-cent radio book series—each on a popular subject—are available. The titles are:

BOOKS ARE ALL UNIFORM

Every book in the GERNSBACK EDUCATIONAL LIBRARY has 32 pages—with illustrations varying from 30 to 66 in number. Each title volume contains over 15,000 words. Positively radio's greatest book buys! If you do not think these books worth the price asked, return them in 24 hours and your money will be instantly refunded.

RADIO PUBLICATIONS

101 Hudson Street New York, N. Y.

RADIO PUBLICATIONS, Dept. RC-938
101 HUDSON STREET, NEW YORK, N. Y.
Gentlemen: Please send immediately, POSTPAID, the book numbers circled below. I am enclosing cents—each book being 10c.

Send FREE listing of 48 new 10c publications.

Name

Address

City State

Remit by check or money order—register letter if you send cash or unused U. S. postage stamps.

MAIL COUPON TODAY!

THE RADIO MONTH IN REVIEW

(Continued from page 135)

that city was found to have the right type of blood, and immediately flew to New York.

The fundamental alliance between broadcast and cinema technique was again evidenced last month when members of the Sound Section, Technicians Branch, Academy of Motion Picture Arts & Sciences, were appointed to visit the new KNX broadcasting studios and the C.B.S. Hollywood plant. A tour was arranged to enable studio sound engineers to compare the techniques of broadcast engineering as compared to their own studio operation.

At the I.R.E. 13th Annual Convention in the Hotel Pennsylvania, New York City, last month, about 50 technical papers were presented during 10 technical sessions.

By dangling before contestants the promise of a public stage audition more than 200 entrants were enrolled last month for a radio amateur contest as a drawing card for the Amateur Ironers Institute; the contest was held in the American Legion auditorium in Balboa Park, San Diego County, Calif. The main idea of the Show was to ballyhoo electric ironers but in this radio played a considerable part.

Radio listeners were informed of the progress of the contest through three 15-minute Talent quest programs, 4 half-hour

Stage Broadcasts, and the final series of 3 Prize Programs featuring the 6 winners.

To carry out the promise of a public stage audition an elaborate amount of equipment and preparation was necessary. Remote control from KGB had to be installed at the stage for the nightly broadcasts; an automatic applause meter for registering audience appreciation had to be rigged up, and a Public Address system involving a half-dozen microphones was needed.

In honor of Air Mail Week, last month, a unique broadcast was arranged by American Airlines, Inc., radio engineers; operators of Radio Station KRBC, Abeline, Texas; and west-Texas post office and civic authorities, utilizing the radio equipment of an American Airlines "Flagship" Sleeperplane and shortwave equipment of KRBC.

According to an exclusive story to *Radio-Craft*, the program, originating at Abeline Airport, when the Skysleeper made a special stop there for the occasion, was broadcast over a special frequency assigned, by the F.C.C., in addition to the regular night and day frequencies used for ordinary operations.

A Headquarters broadcast to Little Rock radio police to pick up 5 alcoholic patient escapeses from the State Hospital last month was 120 per cent perfect in results. Patrolmen picked up and delivered 6 to the hospital!

WOR's publicity men have a tall story they swear is true which must make Bob Burns envious (says the *N. Y. World-Telegram's* Alton Cook). According to the WOR version, a man came to the transmitter at Carteret, N. J., one day last month, complaining that he heard programs all night, even though his radio receiver was turned off. He couldn't sleep.

Believe this or not, as you please—but they say WOR engineers found the man worked at a machine which had carborundum grinding wheels. Fine particles of carborundum got into his mouth and, along with his gold teeth, set up a crystal receiver with the bed-spring as antenna (and ear-response by bone conduction?—*Editor*). Brushing his teeth removed the difficulty.

Senor J. E. Vasquez Andrade, editor of the newspaper, *Universal*, in Lima, Peru, used radio last month to register the biggest South American scoop of the year.

Listening-in on his short-wave receiver, Vasquez Andrade idly happened to hit the wavelength of the station, "La Voz de Colombia," in Bogota, the Colombian capital, when the President of Colombia, Dr. Alfonso Lopez, announced his abdication after a coup d'etat.

The Peruvian editor immediately put out an extra edition of his newspaper, front-paging the Colombian upheaval—24 hours ahead of journalistic rivals who received it then officially.

Please Say That You Saw It in RADIO-CRAFT

Arrangements have been made by the Mexican government for the hooking up of 53 Mexican stations to carry a daily schedule of propaganda and cultural programs to 12,000,000 listeners. Link will take in short-wave as well as long-wave outlets, it was reported from Mexico City, last month. (We wonder how long it will be before dictator nations attempt to use this medium to push loud propaganda over our backfence?)

Spatari, an international code language, will be used by 11 Central-South American stations in a series of experimental broadcasts. Language is essentially based on the music scale of sounds, and was invented in New York by Carlo Spatari, who has not had much luck in interesting U. S. stations or anybody in giving it a tryout, *Variety* pointed out, last month.

Dave Driscoll, special-events' mike-man on Mutual, is suffering from ruptured blood vessels in his cardrums after descending a shaft below the Lincoln tunnel, N. Y., for a broadcast.

Several months ago Bob Trout, C.B.S.'s special eventer, fainted when prowling deep in the excavations being burrowed for the new 8th Avenue subway in N. Y.

Warden W. W. Waid of the Texas prison system has requested all Texas judges not to set execution dates for Thursday, a Ft. Worth news item stated last month.

Waid explained that prisoners broadcast for the WBAP prison show, "Inside the Walls," on Wednesday nights, and since all Texas condemned men are executed during the first minute of the day, an execution scheduled for Thursday would work a hardship on the nerves of the prisoners taking part in the program.

Approximately 50,000 citizens, school children and notables attended the rites held in the Meiji Shrine stadium, last month, for formal installation of Prince Chichibu as honorary president of the Society for Celebration of the 2,600th anniversary of the Accession of Emperor Jimmu to the Japanese Throne.

A feature of the event was a radio broadcast to the nation, for the first time in Japanese history, of the Prince's message accepting the honorary post, stated *Trans-Pacific* of Tokyo.

High-school children spend too much of their spare time listening to "the radio" and show very little discrimination in the type of program they enjoy, according to the results of a radio survey carried on in the New York City school system, and made public last month by A. H. Lass of Abraham Lincoln High School.

Conducted at the Abraham Lincoln High School, the survey tested the tastes and preferences of 988 boys and girls. It was found that children spend on the average 2 hours and 5 minutes each day listening to the radio programs, while they spend only 1 hour and 20 minutes on their reading. It is a "sad" fact, the report declares, that most of the listening is on a "generally low plane." Good educational programs hold little appeal to the students, continued the *N. Y. Times*. (Food for thought.)

About 75 per cent of the students surveyed, however, asserted that they found the radio fare helpful in their school work.

Reported Ben Gross in his column, "Listening In", in the *New York Daily News* last month:

"More than 90 colleges today give

courses in radio speech," says Orson Welles, the Mercury Theatre actor and director, who is also an important personality on the air. "Reading the figures in a recent survey, I found that the writing of comedy and dramatic sketches is being taught in 57 institutions. And although television is still around the proverbial corner, 13 universities are giving courses on this topic.

"As for microphone acting, 53 schools are now giving regular instruction in this field . . . and 21 of them are specializing in Radio Music. Broadcasting has had a tremendous effect on legal practice. A whole body of legal precedent has grown up around the business negotiations of the broadcasters. So 5 universities have begun lectures on Radio Law in their schools for prospective lawyers."

According to E. L. Gove, Technical Supervisor of United Broadcasting Company, the company plans distribution of 100 facsimile receiving sets in various locations in Cleveland, Ohio. From these sets results of the experiment will be compiled in order to guide engineers in making the service available to the public.

Spain's partisans in Puerto Rico have been banned from broadcasting over San Juan's station WKAQ. The station action is the result of the intense feeling in the Spanish colony partly resulting from the radio broadcasts.

Interesting highlights of the television portion of the I.R.E. convention of last month (as briefed from the *N. Y. Times*) include the following:

One engineering designer described a system that "brings television clarity 10 times nearer" the eye goal than it was a year ago. Another told of a device that in a few inches inside a glass bulb increases an electric current "many hundreds of millions of times," or at least 100 times the "electrical gain" or amplification possible with the device a year ago.

A year ago, Dr. Zworykin explained, multipliers operating on the magnetic principle were capable of gains of about 1,000,000. With the aid of lantern slides he demonstrated the principle involved and showed in a glass bulb an electrostatic multiplier, only 1 inch in diameter and 1 inch long, that "increases a current more than 30,000,000 times."

Describing new work to obtain greater contrasts in the kinescope, the large flat-ended cathode bulb on the end of which a received television image is viewed, Dr. Law said this tube had been developed to the point where it has "versatility at least as great as the ordinary photographic paper, as far as contrast is concerned."

"The present iconoscope," Mr. Iams said, "is 10 times as sensitive as ordinary photographic film was a year ago. The tube should make it possible to use only about 1/10 the illumination now necessary in television studios and still keep the depth of focus of a scene." (The cathode-ray iconoscope is used in the transmitter, to pick up the image later reproduced by the cathode-ray kinescope of the receiver.)

"There has been a fiasco in British television circles," says "Ether," writing in *Ireland's Own* (Dublin), last month. "Gradually the London headquarters have worked up interest in the invention till now they

(Continued on page 185)



NEW MODEL 432 ONLY \$21.60

- Separate Plate Tests on Diodes and Rectifiers Tests
- Uses Triplet Direct Reading Instrument (GOOD-BAD) Scale
- Line Voltage Adjustment

Complete in attractive, sturdy quartered-oak case; suitable for counter or portable use. Sloping etched panel of silver and black.

Other Readrite Tube Testers Also Are Available

Readrite

READRITE METER WORKS

916 COLLEGE AVE. BLUFFTON, OHIO

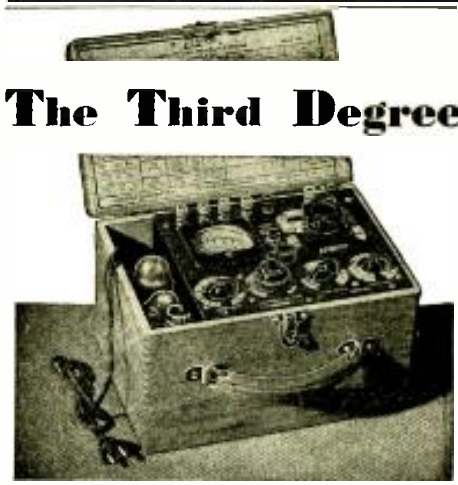

for CONDENSERS

• The new AEROVOX CAPACITY & RESISTANCE BRIDGE provides the most accurate means yet introduced outside the best-equipped laboratories. for thoroughly testing condensers of all types. • Also provides for other measurements and test functions. • Simple. Reasonable. Indispensable. • Ask your jobber to show it to you. Ask for literature. • Or write us direct.



Please Say That You Saw It in RADIO-CRAFT

A FREE BOOK FOR EVERYONE IN RADIO

RADIO-CRAFT—complete in everything radio men need, gained popularity and leadership in a few years. Never once has RADIO-CRAFT shortened its stride of editorial progress. Broader in news scope—excellence in illustrations—continued improvement in editorial technique—accuracy in wiring diagrams and schematics—these are the basic ideals upon which RADIO-CRAFT success has been achieved.

The publishers of RADIO-CRAFT make you a very liberal offer—they want you to read every monthly issue—they want you to get the benefits as do thousands of other readers—they have arranged a special offer with an attractive premium—and they have made a special price for you.

To readers of this announcement the **SPECIAL OFFER IS A SEVEN MONTHS' SUBSCRIPTION TO RADIO-CRAFT and a FREE COPY of the 1938 RADIO REFERENCE ANNUAL.** If you are a regular subscriber at the present time, you may take advantage of this opportunity just the same. The publishers will be glad to extend your present subscription an additional Seven Months, and at the same time, send you a FREE copy of this new book.

Use the coupon below for entering your subscription to RADIO-CRAFT.

Here is the Contents of the 1938 RADIO REFERENCE ANNUAL

SET BUILDING
This particular section of the 1938 RADIO REFERENCE ANNUAL contains a description of a number of important, as well as interesting receivers. They are as follows: A Simplified Converter; A Farm Battery Receiver; An Executive's A.C.-D.C. Desk Set; Handy Book-End Novel Receiver. Other receivers described are: Crystal Set, Portable Battery Receiver, and several others. Each receiver is described accurately, complete with constructional data and list of parts required.

SERVICING
This chapter is devoted to Radio service instruments in general. Special emphasis is given to a number of the more essential instruments—they are: Service Oscillators, Mixer Circuits, V.T. Voltmeters and an Interference Eliminator.

PUBLIC ADDRESS
For those who find public address their chief interest, here you will find complete

design and construction on a P. A. Tuner; a Handy Amplifier; and an Infinite Baffle Loud Speaker.

TEST EQUIPMENT
Radio Service Men who prefer to build their own equipment will find all the construction details necessary for building the following: Condenser Analyzer, Midget Oscilloscope with 1" and 2" tubes; Service Audio Oscillator.

GENERAL INTEREST ARTICLES
A variety of topics have been selected for their interest and importance. These subjects cover: Home Broadcaster; Remote Set Tuning; Carrier-Type Interphone Systems; and a number of others.

MISCELLANEOUS
A comprehensive index of important articles which appeared in RADIO-CRAFT during 1937. This section also includes data on recently developed tubes and many other helpful hints and suggestions.

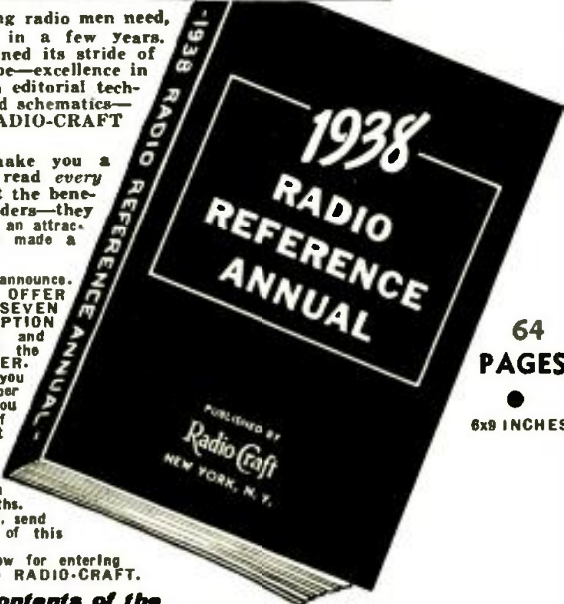

Over 90 Illustrations

RADIO-CRAFT

99 Hudson Street, NEW YORK, N. Y.

RADIO-CRAFT, 99 Hudson Street, New York, N. Y.

RC-938

Gentlemen: Enclosed you will find my remittance of One Dollar (\$1.00) for which enter my subscription to RADIO-CRAFT Magazine for Seven Months. Send me, ABSOLUTELY FREE, and POSTPAID, my copy of the 1938 RADIO REFERENCE ANNUAL.

New Subscriber Extend present subscription

Name Address

City State

(Send remittance by check or money order. Register letter if you send cash or unused U. S. Postage Stamps.)

Action! Thrills! Sights! Fun! — In Every CANDID CAMERA Shot!

The country's new craze—CANDID CAMERA Shooting. Everyone from north to south—east to west is using a minicam. Anywhere you go—day or night—under any conditions, there're thrills taking CANDID CAMERA pictures. In a flash you catch your subject—a popular golfer, a screen or radio star, a ball player, your children, an action scene—anything you want.

This minicam, popularly priced at \$3.98, is comparable to others setting at a much higher cost. It takes 16 pictures, either instantaneous or time exposures. Equipped with Wollensak 50 mm. strong lens, speed shutter and accurate "spy glass" view-finder. Fixed focus guarantees sharp pictures, 1 7/8x1 1/4 inches. Enlarges with clarity up to 8x10 inches. Has special compartment to carry extra film roll and tripod socket for mounting. Uses economical Kodak 127 or Agfa A8 film in color or black and white. Housing built of unbreakable Bakelite-Composition. Camera weighs only 9 ounces, measures 5" long x 3" high x 2 3/4" wide. Easy to operate and extremely inexpensive to use.



Shipped POST-PAID anywhere in U.S.A. with guarantee of safe delivery **\$3.98**

HUDSON SPECIALTIES COMPANY • 40R West Broadway • New York, N. Y.

THE RADIO MONTH IN REVIEW

(Continued from preceding page)

in front of a movie camera and sound-recording machine, and recorded—both in sound and on the screen—all their statements which will be presented at the trial, readers of the *N. Y. Post* learned last month.

Recording shortwave broadcasts in foreign languages, Prof. C. A. Wheeler, head of romance languages at Tufts College, Medford, Mass., plays the records for his classes as a part of instruction routine, *Broadcasting* magazine reported last month.

Transcontinental and Western Air, Inc., last month reported that a searching party had reached the wreckage of a TWA airliner on Buena Vista peak in Yosemite National Park.

Shortwave radio communication was to be established with the searching party to bring in details from the almost inaccessible scene of the March 1 wreck in which 9 persons were killed.

"AIR DOGFIGHTS"

Under the title of "Dogfight on the Air Waves," *The Saturday Evening Post*, last month, printed a lengthy and interesting story by Chester T. Crowell which contains almost incredible information on the inside workings of the air propagandists. He dishes up a walloping expose to support his claim that "There is war in the ether on a much more extensive scale than on land or sea."

Hot news of the month had Uncle Sam exchanging lefts and rights, verbally, with commercial broadcasters, in an effort to push across the idea of a Government-owned and -operated radio station, to cost \$750,000 and with annual operating expenses of \$100,000. Avowed purpose was to put "goodwill" programs into territory south of the Panama Canal. The bill (brought by Rep. Celler, D., New York), proposed one week, was called off the next, with hearings "postponed indefinitely." Combined opposition of N.A.B. (N.B.C., C.B.S., M.B.S., et al.), G.E. and Westinghouse, served to convey the idea that perhaps Rep. Celler didn't quite hit the nail on the head when he stated that "there is more talent to be found in Washington." Instead, it was pointed out, shortwave-casting the "official" remarks of Government employees via an Administration station would almost certainly keep us in international hot water; and, S.-W. coverage was now adequate over present, non-Government channels. Stating that "the Administration is in favor of the bill," Rep. Celler is reported to have declared "the fight for enactment of the measure will go on."

Close on the heels of the Celler plea for a Washington, D.C., U. S. Gov't shortwave broadcaster, came a call from Senators Dennis Chavez (D., New Mexico), and Wm. G. McAdoo (D., Calif.), to put up in San Diego, Calif., an anti-Berlin—Rome—Tokyo propaganda station, pointed toward S.A., at an installation cost of \$1,200,000, and maintenance expenses ("excluding program and wire costs") of \$160,000. With experience gained from the Celler battle, it's likely the Chavez-McAdoo combination will be able to give a better account of itself before the Senate, than the former did before the House Naval Affairs Committee.

Please Say That You Saw It in RADIO-CRAFT

An Italian report, last month, stated that the Council of Ministers had approved plans for expanding Mussolini's shortwave radio broadcasting facilities. Writing in the *N. Y. Post*, last month, David Davidson pointed out how shortwave radio from Germany is helping Herr Hitler keep his flock united in spirit by giving German-born people in America cheery, personalized items and songs in their native tongue.

From Berlin comes a *U.P.* report that German engineers in roving direction-finding cars claim to have placed the anti-Stalin mystery station as inside the Russian border and near the western frontier of the Baltic States; the S.-W. broadcaster, operating on 26 and 32 meters, suggests that Stalin's "... days are numbered! Your murders are about to take your own head." A radiogram from Moscow to *The New York Times* claimed that the Italian station IRF had been sending out anti-Soviet reports in the Russian language.

Having conceived the bright idea of shortwave broadcasts to Arabia, in the native tongue, the British Broadcasting Corp. finds its headaches have only begun. Unable to get a "yes" or "no" report on the general acceptance of these broadcasts, the suggestion has been made that phono recordings of the comments of listeners, especially Arabs, be made and shipped to England for analysis. The scheme is receiving favorable attention. But why wait that long before modifying the program? Why not use a shortwave talk-back circuit, make the recordings at some designated listening post in London, and translate them immediately?

N.B.C. last month unbuttoned its pocket-book and absorbed the expenses involved in getting onto the air President Roosevelt's shortwave broadcast, before the Board of Governors of the Pan-American Union, to South and Central American countries.

Congressman Bernard, Minnesota Farmer-Laborite, last month asked the Federal Communications Commission to investigate Nazi propaganda over the shortwave radio lanes.

LEGISLATION

Exercise of government's regulatory power to prevent doctors' diathermy machines from turning the airwaves into a sawmill was proposed in a bill offered the U. S. Senate last month in accord with recommendations of the Federal Communications Commission.

The Public Service Commission would regulate aircraft and radio under a proposal introduced, last month in Albany, in the Constitution Convention by State Senator John T. McCall (D., Manhattan). The proposal also would extend the broadest powers to the commission over all other public utilities.

Radio and television messages are to be secured against search, according to a bill introduced in Albany, last month, by Charles Poletti (D., and A. L. P., Manhattan), who adds these to other messages, conversations, persons, houses, papers and effects, if we are to believe the ordinarily reliable *N. Y. World-Telegram*. (Tell us, please, Mr. Poletti, how you plan to secure "television messages" against "seizure."—*Editor*)

The House last month defeated the Connery resolution calling for a Congressional investigation of radio broadcasting.

SLIP-STICKERS

Engineers last month were most generous in contributing to the advance of radio. Students at Armour Inst. of Technology, however, won the leather medal for outstanding "cooperation" when they helped inventors Emil Daniel and Lawrence Strocchia measure the osculatory figure-of-merit of various subjects. On their "kiss-o-meter"—to quote *U.P.*: "an ammeter connected with batteries, a voltmeter, switches and an amplifying system," each subject grasps an electrode—couples recorded as follows: Mother and daughter, 20; mother and son, 15; girl friends, 15; married couples, depending upon the number of years married, 30-87; engaged couples, 90-95. From there on up to 120 a bell kept ringing!

That it is possible to "skin temper" steel to the required depth within 5 seconds, by operating on the known principle that radio waves follow the surface of metal, was announced last month by *Science Digest*. (In an automobile crankshaft, for instance, Westinghouse engineers point out, the ideal requirement is that it be resilient and ductile within, hard on the bearing surface.)

Says the Dept. of Terrestrial Magnetism, Carnegie Inst. of Washington (Wash., D. C.), sound non-magnetic castings of copper, brass, and aluminum for use in magnetic measurements can now be produced. The method employs close control of the melting temperatures, a method of purification of the metal, and design of the patterns.

According to *The Trans-Pacific*, of Tokyo, last month, Jap engineers of the Hochi are singing that the basic unit of minimum noise, or "zero-db.", should be 0.001- of the basic unit which has the lowest audible value. Germany has a different value for the unit; while the American standard of 0.0002- was accepted last summer, in an international meeting, by Great Britain, France and Italy. Chorus: "You go your way, I'll go my way . . ."

Dr. B. F. J. Schonland, of the University of Watersrand, Johannesburg, South Africa, has doped out a scheme to utilize static for photographing, in daylight, lightning flashes that ordinarily could be recorded only at night. The usual procedure, and which of course is possible only at night, is to leave the camera shutter open until the flash, then close the shutter; daylight overexposes the plate and renders this system useless. However, the good Doctor invented a system whereby the static impulses of the faint "leader" flash, which zig-zags to earth in steps ahead of the main flash, is received by a shortwave "static"-receiver which actuates the camera shutter-opening mechanism 0.005-second before the return stroke appears on the scene.

Fire and accident hazards are reduced, in the newest regulations, "The Standard for Power-Operated Radio Receiving Appliances," sponsored by the Underwriters' Laboratories. Power transformers, for instance, which might "explode"—due to ignition of gases generated on overload—must be enclosed in non-combustible containers; resistors and condensers in combustible cabinets—certain plastics cabinets, for instance—under certain circuit arrangements, must be enclosed in non-combustible containers, according to reports last month. Many other safety factors were recommended.

(Continued on page 189)

Please Say That You Saw It in RADIO-CRAFT

F FOR THE RADIO SERVICE MAN, DEALER AND OWNER

The man who enrolls for an I.C.S. Radio Course learns radio thoroughly, completely, practically. When he earns his diploma he will KNOW radio. We are not content merely to teach the principles of radio, we want to show our students how to apply that training in practical, every-day, radio service work. We want them to make good, to make money, to be successful radio experts.

INTERNATIONAL CORRESPONDENCE SCHOOLS
 Box 6679-D, Scranton, Penna.
 Explain fully about your course in the subject marked X:
 RADIO
 EXPERIMENTAL TELEVISION
 SOUND TECHNICIANS
 AVIATION SECTION OF RADIO OPERATING
 Name _____ Age _____
 Address _____

PHONOGRAPH RECORDS
 12-DECCA, BLUEBIRD or VOCALION records-\$1.00
 8-VICTOR, COLUMBIA or BRUNSWICK records-\$1.00
 Each record is the standard 10" and plays both sides.
 Hot dance numbers, vocal instrumental, waltzes, old timers, cowboy, hill billy, etc.
 All popular artists. Hurry while they last. No C.O.D.'s.
SEND FOR OUR GIANT SUMMER CATALOGUE.
UNITED RADIO COMPANY
 58-P Market Street, Newark, N. J.

HAMS-FANS!
 The 1938 edition of the famous Hammarlund SHORT WAVE MANUAL is chock full of high and ultra-high frequency receivers and transmitters. No ham or experimenter can afford to be without a copy.
Send 10c for your copy now!
 HAMMARLUND MFG. CO., INC.
 424 W. 33rd St., N. Y. C. Dept. RC-9.

Service is Made Easier with RADIO CHASSIS CRADLE!
 Service shops need the RADIO GIMBLE (chassis cradle) for efficient servicing, testing and repairing of receivers or amplifiers. Equipment clamps to cradle which can be adjusted to any angle. Accommodates chassis up to 13 x 12 x 23 inches. Excellent for displaying receivers. Write for illustrated circular RC1
 WM. A. THOMAS CO., 321 Caroline St., Neenah, Wisc.

YOU NEED ALL 8 Rider MANUALS
 JOHN F. RIDER, PUBLISHER
 404-4 th Ave., New York City

OPPORTUNITY AD-LETS

You will find many remarkable opportunities and real bargains in these columns. It will pay you to read and investigate the offerings made every month by reliable firms, dealers and individuals from all over the country. No matter what you may be seeking, whether supplies, automobile accessories, the opportunity to make money, or anything else, you will find listed here the best and most attractive specials of the month. Advertisements in this section five

cents a word for each insertion. Name, address and initials must be included at the above rate. Cash should accompany all classified advertisements unless placed by an accredited advertising agency. No advertisement for less than 10 words accepted. Ten per cent discount for 6 issues, 20 per cent discount for 12 issues. Objectionable or misleading advertisements not accepted. Advertisements for the October issue must reach us not later than August 5th.

RADIO-CRAFT

99 HUDSON STREET

NEW YORK, N. Y.

ADVERTISING

ADVERTISE. 24 WORDS. 65 NEWSPAPERS. MAGAZINES. \$3.00. Goodall Agency, 742 Market, San Francisco.

ANTIQUES

OLD GLASS, DOLLS, STAMPS, COINS, MINERALS. Indian relics, beadwork, books, Catalogue 5c; Indian Museum, Northbranch, Kansas.

AVIATION

AIRPLANE MECHANIC'S LICENSE QUESTIONS, with answers, diagrams, \$1.25; Engine Mechanic's \$1.25. Both \$2.00 remittance. Meyer Engineering, Box 8, Hempstead, New York.

BOOKS AND MAGAZINES

WE HAVE A FEW HUNDRED RADIO ENCYCLOPEDIAS, by S. Gernsback, second edition, originally sold at \$3.98. Book has 352 pages, weight 3 lbs., size 9 x 12 inches. Red morocco—keratol flexible binding. Send \$1.98 in stamps, cash or money order and book will be forwarded express collect. Technifax, 558 W. Washington Blvd., Chicago, Illinois.

MECHANICS, HANDYMEN, AUTO OWNERS. BOOK-let of handy hints, 10c (coin). S. Laffer, 861 East 27th Street, Brooklyn, N. Y.

YOUR FAVORITE MAGAZINES—HALFPRICE! CATA-log 10c. Magazine Exchange, Baseline—W, San Bernardino, Calif.

ASSURE YOURSELF OF GREATER PROFITS BY doing radio service jobs more quickly. Authentic service guides show you the way to locate and correct troubles in any radio receiver. Gernsback Official Radio Service Manuals—published in seven complete volumes—show you how to complete more repair jobs in less time—how to earn more money by faster servicing. Turn to page 132 of this issue and learn how you can get any edition of the Manuals on a free inspection plan.

10c RADIO BOOKS FOR EVERYONE! FOUR IM-portant titles—Beginners' Radio Dictionary; How to Have Fun with Radio; How to Read Radio Diagrams; Radio for Beginners. New, authentic and modern, each volume contains 30 to 60 illustrations. Over 15,000 words in each book. Sent postpaid anywhere, 10c per book. Radio Publications, 101-C Hudson Street, New York, New York.

THE RADIO-CRAFT LIBRARY SERIES—TODAY'S largest technical library of low priced books covering radio, air conditioning and refrigeration. Complete details on the fifteen books in this series, including new titles covering cathode-ray oscilloscopes, breaking into radio servicing and modern testing methods, appear on page 184 of this issue. Turn to this announcement now, and read the advertisement on the RADIO-CRAFT LIBRARY SERIES.

BUSINESS OPPORTUNITIES

GIANT MAIL—OPPORTUNITIES, INCLUDING 52-page magazine, tips, added income ideas. All for 10c. C. Katz, 4254 N. Kimball, Chicago, Ill.

WANTED, RELIABLE MEN AND WOMEN TO SELL high grade cold creams, bath salts and other cosmetics, 40% commission. Repeat orders assured. Frank D'Augustine, Windermere, Florida.

SELL PATENTED KEY HOLDER. TAKES NO ROOM in pocket. Excellent premium item. Send ten cents for three samples. J. Sindler, Malden, Mass.

SELL CONSUMERS, DEALERS, HAVANA CIGARS. Commission or buy wholesale. Sullivan Cigar Company, Tampa, Florida.

RELIABLE PERSON IN EACH TOWN FOR OWN advertising distributing agency. No selling. Good paying business. Dawson's Advertising, Cape Girardeau, Missouri.

CAMERAS & SUPPLIES

AMBERTINT 16MM. CAMERA FILM \$1.85 FOR 100 feet including machine processing. Daylight loading. Weston 8 Hollywood Studios, South Gate, Calif.

JOIN THE THOUSANDS OF CANDID CAMERA FANS—a genuine minicam equipped with Wollensak 50 mm. lens, speed shutter and accurate "spy glass" view finder. Fixed focus assures sharp pictures 1 1/4 x 1 1/4 inches. Enlarges with clarity up to 8 x 10 inches. Has special compartment to carry extra film roll and tripod socket for mounting. Uses economical Kodak 127 or Arga A8 film in color or black and white—takes 16 pictures. Finishing built of unbreakable bakelite composition. Camera weighs only 9 ounces; measures 7" long by 3 1/2" high by 2 1/4" wide. Easy to operate and inexpensive to use. Shipped postpaid anywhere in U.S.A. with guarantee of safe delivery—\$3.98. Hudson Specialties Company, 48R7 West Broadway, New York, N. Y.

COINS AND STAMPS

INDIAN HEAD, LINCOLN PENNIES, WANTED, ALSO postage stamps. Send 10c for buying and selling lists. 100 commemoratives U. S., Great Britain, etc., only 50c. U. S. Imperforates two different sets 25c. Box 191, Gloucester, Mass.

STAMP COLLECTORS: GET CANADIAN ANNUAL—Features Canadian, United States, Newfoundland, Colonial and Foreign stamps. Complete listing of Philatelic supplies. Sixty pages, hundreds of illustrations to aid collectors. Sent FREE. Gray Stamp Company, Dept. B. C., Toronto, Canada.

WORLD'S BIGGEST MAP STAMP. CORONATION, Jubilee, over 50 others, 5c with approvals. Lawrence Shultes, Box 113, Berne, N. Y.

FREE. APPROVAL APPLICANTS SEND 3c POSTAGE and receive complete set of Costa Rica Air Mail. Book Nook, Box 206, Huntington Park, Calif.

INSTRUCTION

GROWING PLANTS WITHOUT SOIL. BEGINNING new industry with same chance that radio offered in its infancy. Instructions for equipment, mixing and use of chemicals, 10 formulae \$1. Dorn and Lawson, 4615 W. Washington Blvd., Los Angeles, Calif.

USED CORRESPONDENCE COURSES AND INSTRUC-tion books bought, sold, rented, exchanged, catalog free. V. W. Vernon, Henagar, Ala.

INVENTIONS AND PATENTS

INVENTIONS—PATENTED, UNPATENTED, BOUGHT outright, royalty. Write Arellano-Power Co., 1 LaSalle, Chicago, Illinois.

MACHINERY, TOOLS AND SUPPLIES

ELECTRIC PEN, ENGRAVES HARDEST STEEL. Dollar prepaid. Hudson Bros., East Syracuse, N. Y.

PYRD PANTAGRAPH—THIS ELECTRICAL OUTFIT turns designs permanently on leather, wood, cork, gourds, bakelite, etc. Simply plug pyro electric pencil into any 110 v. A.C. or D.C. line and it is ready to use. Reduce or enlarge any design with special pantagraph included. Complete kit and instructions, \$2.75. (Add postage for shipping 3 lbs.) Wellworth Trading Company, 560 E. West Washington Street, Chicago, Illinois.

MISCELLANEOUS

MEXICAN DIVORCES: NO PUBLICITY. AMERICAN attorney. Box 1736, El Paso, Texas.

MONUMENTS AND TOMBSTONES

GENUINE MARBLE, GRANITE, FREIGHT PAID. Catalog free. \$11 up. United States Marble & Granite Co., A-27, Okeco, Fla.

RADIO-CRAFT FREE SWAP COLUMN

Space in this department is solely for the benefit of our readers, who wish to exchange radios, parts, phonographs, cameras, bicycles, sporting goods, books, magazines, etc., without profit.

Since we receive no money for these announcements, we cannot accept responsibility for any statements made by the readers.

Only one advertisement will be accepted from any reader for any one issue. No advertisement to exceed 35 words, including name and address.

WILL SWAP—X-RAY MACHINE, LABORA-tory type for 3" oscilloscope and frequency modulator—or what have you? John T. Lipani, 6 Ashland Street, Boston, Mass.

HAVE A NEW WESTINGHOUSE 200 WATT A.C. generator with extra brushes and full instructions. Will trade for what have you. Becker Radio Service, 315 Harrison St., Grand Ledge, Michigan.

SWAP HAWK-EYE VEST POCKET CAMERA, 127 film—"Practical Radio Communication" by Nilson & Hornum, textbook for commercial license examinations (value \$5). Interested, radio service parts, what have you? S. Lysyak, 53 Hadwin Street, Central Falls, R. I.

NEW RIDER'S VOL. V. RADIO RECEIVING and Television Tubes by Moyer and Westrel, excellent condition. Want Graham's Calculus, Radio Engineering books, television books. Write first. J. Doyle, 13 Doehn Avenue, Kitchener, Ontario, Canada.

2 MAGNETIC SPEAKERS: R.C.A. MODEL 100, and Freed-Eisemann. Jewell 250 D.C. voltmeter, trickle charger, also battery charger, exchange all for testing equipment, or tube tester. J. Marsh, 111 Van Liew Ave., Milltown, New Jersey.

HAVE JEWELL 0-50, 0-250, 800 OHMS PER volt D.C., and Weston 0-4, 8, and 150 volt A.C. table meters, also four Walbert Univernier and six National Velvet Vernier dials. Need candid camera, power transformers, 25Z5 tubes or? Roland Forbes, 111 Woodstock St., Somerville, Mass.

WANTED: EARLY MURDOCK CRYSTAL and loose coupler set. Also want any type of coherer. Exchange radio or photographic parts, or what you want. R. D. Tilletson, 40 Mannix Ave., No. Plainfield, N. J.

HAVE BABY BROWNIE CAMERA AND three section 11 point Yaxley switch. Will trade both for good used photo-cell. If interested write giving condition, age and make of cell. Paul Bahr, 1205 West 10th, Marion, Indiana.

WILL SWAP A MAGNAVOX DYNAMIC speaker, 6-12 volt field; Ford generator rewound for 6 volt slow speed wind charger and a metal locator. What have you? Amos Thorson, Rural Route 2, Verona, Wisconsin.

MOTORS AND GENERATORS

MODEL ELECTRIC MOTOR, PARTS COMPLETE 25c. Ralph Potter, Huntington, W. Va.

GENERATORS, MOTORS, LAMPS, SUPPLIES. BAR-gain list for stamp. Dennis Electric, 3 Stanchfield, Minnesota.

PHOTOGRAPHY

ROLLS DEVELOPED—25c COIN. TWO 5 X 7 DOUBLE weight professional enlargements, 8 gloss prints. Club Photo Service, LaCrosse, Wisconsin.

PRINTING

NAME CARDS, 39 CENTS HUNDREDO. PROMPT. Lewis Press, Malvern, Ohio.

RADIO

YOU RADIO MEN WHO WANT TO READ RADID'S Liveat Magazine every month and learn about every new development which takes place—in servicing, in new tubes, in foreign developments, in facilities, in television, in test equipment, turn to this announcement on page 186 and learn how you can subscribe to RADID-CRAFT and get an invaluable free premium.

BAKELITE PANELS, POSTPAID, ANY THICKNESS, cut to your dimensions. Write Hackbush, 1689 Linden, North Tonawanda, New York.

SONG POEM WRITERS

SONGWRITERS! MELODY FOR WORDS \$1.00. Littig, 315 Mason Theatre, Los Angeles, California.

SUPPLIES

3,000 GOLF CLUBS, BANKRUPT STOCK, FIVE club set \$2.50. Lincoln Surplus, 123 S. Galena, Freeport, Ill.

WILL TRADE SEVEN TUBE HALLCRAFT-ers communications type receiver for—what have you? C. A. Lanham, W9JLIC, 404 West Union, Bloomington, Illinois.

ONE OFFICIAL DOERLE 5 TUBE A.C. SHORT wave receiver 16 - 550 meters trade for B.F. oscillator or test instruments, or what am I offered? R. I. Gardner, 2689 "L" Street, San Diego, Calif.

WANTED: RIDER'S MANUALS, VOLUMES 4, 5, 6, 7 and 8. Will trade moving picture equipment. Write and give details. Joe Richards, 332 E. Helm Street, Brookfield, Missouri.

HAVE A NUMBER OF SIGNAL GENERATOR coils, small universal wound, 95-980 kilocycle, E. J. Kujanik, 62 Bruce Street, Gait, Ont., Canada.

I HAVE A COMPLETE U.S. SCHOOL OF Music guitar course and 3,000 foreign stamps to trade for radio parts, test equipment or service manuals. Floyd Goff, Route 1, Black Mtn., No. Car.

WHAT OFFERED FOR GOLF CLUBS AND bag, Successful Money Making Business course, Niagara School Piano course, Gregg touch typewriting course, all complete, new Prefer speed camera, enlarger, typewriter, short wave radio, Robert Pollock, Chanute, Kans.

HAVE LARGE HIGH QUALITY MASSIVE console Temple combination electric phonograph auditorium speaker, wonderful home set. Valuable ladies Swiss white gold wrist watch, band to match, perfect. Want Scott radio, or offer. Carrie Pollock, Chanute, Kansas.

HAVE 6 ELECTRONIC CONVERTERS, 32 volts D.C. to 110 volts A.C. at 100 watts. Also 1 genemotor, 32-180 volts D.C. and 1 genemotor 6-180 volts D.C. All A-1. What have you? E. Bruhn, Chesterton, Indiana.

WANT OSCILLOSCOPE, HICKOK OR SIMI-lar testing equipment. Briggs-Stratton engine. Have large amplifier, speakers, microphones, guitar and case. Electric clippers, other items. Glenn Watt, Chanute, Kansas.

HAVE PUBLIC ADDRESS EQUIPMENT AND miscellaneous radio parts, equipment to swap. What do you offer? Clara & Frank, P. O. Box 292, Centerville, Calif.

Please Say That You Saw It in RADIO-CRAFT

RADIO MONTH IN REVIEW

(Continued from page 187)

The author continues: "... much equipment has been brought to bear on the subject—microphones, amplifiers, oscillographs, acoustic filters, sound films and phonograph records"—of speech production. "As yet, however, little has even been surmised of the processes in the brain which initiate the actions of speech or of those essential to the appreciation of reception."

I.R.E.

Last month, I.R.E. conventioners at the Hotel Pennsy were told, by Bell Telephone engineers A. A. Oswald and A. A. Roetkin, how radiotelephone signals could be received with a signal/noise ratio improvement of 8 to 1 by slicing off one-half the signal; single-sideband transmission, it's called.

At the same convention, engineers J. F. Farrington, of the Hazeltine Service, told how a "fidelity gate" could be made to afford "optimum" reception quality. In effect, an "automatic selectivity control" circuit narrows the fidelity range as necessary to compensate for increased interference.

The third morsel of mental food was a description, by V. D. Landon of RCA, of a noise-reduction antenna system more effective in urban areas than most previously-developed ones. A "counterpoise" wire picks up the noise voltage only, which is then used to balance-out the noise-voltage portion of the combined noise and signal voltage being received by the regular antenna.

A fourth paper of exceptional interest was read by M. G. Crosby of RCA, who described how ultra-shortwaves may be transmitted with 4 times greater power, using the existing equipment! This 4-fold increase in efficiency is achieved by utilizing "phase modulation", which results in considerable reduction of natural and man-made static, and fading.

As for the system's use in connection with television, he cautiously said: "It might show promise in solving some of the problems of television relaying."

Mr. Crosby also described a new-type receiver, which has been developed for use in the new system. The receiver has the advantage, he said, of "exalting" the carrier wave and thereby substantially lessening the familiar distortion known as "selective" fading which is always present in some degree in all today's long-distance shortwave reception. The receiver, which is no more complicated than the average present-day broadcast receiver with automatic frequency control, is also capable of receiving the present amplitude-modulated waves with the same distortion lessened! (Heretofore, "phase-modulated"-signal receivers, described in past issues of *Radio-Craft*, have far outstripped ordinary broadcast receivers in complexity.)

"Home-Built 11-Tube Set Introduces 'Syncrotronic' Reproduction," a construction article by L. M. Barcus, due to lack of space in September *Radio-Craft* will appear in the October issue.

OPERATING NOTES

(Continued from page 151)

volume control, is usually caused by poor contact of the moving arm of the volume control. Since the volume control is located in the diode circuit of the 75 tube, the above-mentioned symptom is experienced.

The complaint of intermittent reception, wherein the volume level falls, accompanied by resonance hiss, has been traced to open-circuiting 0.05-mf. grid filter condensers in the R.F., 1st-detector—oscillator and I.F. stages. On the other hand, when the volume level falls abruptly with the receiver tuned to some station at the low-frequency end of the broadcast band, and it becomes necessary to re-tune the receiver, check the 360-mmf. series condenser connected across the padder condenser located on the rear wall of the chassis for snapped connecting tabs or blobs of solder at the terminals of the condenser making intermittent contact with the metal jacket. No resonance hiss is experienced at this lower volume level.

RCA VICTOR 262, 263, 281, 381

Reception suddenly bursting forth to a higher volume level and recovering just as quickly is not an uncommon complaint with these models. The trouble has been traced to the pigtail of the 60,000-ohm carbon, oscillator-grid resistor, connected to the cathode terminal of the 6A7 socket, short-circuiting intermittently to the grounded terminal lug of the broadcast-band padding condenser. This removes the initial bias voltage on the 1st-detector—oscillator tube and increases the gain. The resistor is easily moved to correct the condition.

BERTRAM M. FREED

ZENITH MODEL 6D-116

I have fixed several of these sets which have come into the shop "dead". The trouble lies in the 0.02-mf. tubular condenser which is connected to one of the end terminals of the volume control. Manipulation of the volume control tends to pull the wire loose from the condenser body thereby opening this condenser. Replace condenser leaving enough slack in the leads so that the condenser is not drawn taut.

W. L. MCKINLEY

RCA MODELS 13K AND 15K

Motorboating. Low-frequency oscillation, or motorboating, with resultant audio distortion, may occasionally be due to an open joint in the 10 x 10 nif. condenser which is used as a bypass for the audio and driver-stage cathodes. The condition may be either continuous or intermittent. As correction, RCA replacement unit, Stock No. 13025, should be used.

RCA MODEL D 22-1

Intermittent Reception; Distortion. A condition sometimes develops on "radio" operation only which causes low and irregular sensitivity, poor automatic volume control action, erratic Magic Eye deflection, or garbled reproduction. This difficulty may be due to unstable alignment of the 3rd I.F. transformer. This instability is caused by heat from the bleeder resistor R44, R45, which on some chassis is mounted on the rear apron of the chassis directly beneath the transformer. To permanently correct

(Continued on following page)

Please Say That You Saw It in RADIO-CRAFT

METALEX HORNS



- Steel for Wear
- "Ex" for Objectionable Resonances

Election Year Is Always A Public Address Year

If you have never used a Metalex Exponential Horn, it will pay you to try one.

If you are a Serviceman, Dealer or Distributor, we will be glad to add your name to our mailing list. Write us regarding it.

Wright-DeCoster Distributors are always anxious to cooperate.

Write for Catalog.

WRIGHT-DECOSTER, INC.

2251 UNIVERSITY AVE., ST. PAUL, MINN.

Export Dept.: M. Simons & Son Co., New York
Cable Address: "Simontrica"

Canadian Representatives:
Wm. F. Kelly Co., 1207 Bay St., Toronto, Ont.
Taylor & Pearson, Ltd., Edmonton, Alberta



● Everything you need in radio. It's all in this New 1939 RADOLEK RADIO PROFIT GUIDE. Every repair part for every receiver. Newest radio receivers. New 1939 model public address amplifiers, outputs from 5 to 100 watts. New model public address speakers. Test instruments. Technical books. Special equipment. Leading standard brands. Every item guaranteed. It must be right or we make it right.

● And everything under one roof. You get what you want promptly, and exactly what you want. Radolek's immense stock plus Radolek's efficient organization insures you fastest service. 25,000 Servicemen depend on this service and benefit by Radolek's lowest prices. Send now for your copy of Radolek's Radio Profit GUIDE. You save time and money at Radolek!

The RADOLEK Co.

601 W. Randolph, Chicago, Dept. C-21

Send me the New 1939 Radolek Profit Guide FREE.

Name

Address
Serviceman? Dealer? Experimenter?

Listen Comfortably
WITH
BRUSH
"Hushatone"
(pillow speaker)

Put this radio accessory under your pillow and listen to your favorite programs. Write for details.

THE BRUSH DEVELOPMENT CO.
3312 Perkins Ave., Cleveland, Ohio

A Sure-Profit Field for Alert Radio Men!

HOME RADIO DIATHERMY

Hundreds of Radio Servicemen are now representing our Home Short wave diathermy line and acting as our agents in all parts of the country. We offer exclusive territory with absolute protection for all agents accepted by us. Our Short wave diathermy line is standard and has been definitely accepted as "fool-proof" by all who have made the most rigid tests possible on Diathermy equipment.

TERMS: One Third Deposit—One Third 30 days—Balance 60 days.

Our agents have averaged better than \$40.00 a week part-time. Full-time agents can easily do better. We show you how! Write for full particulars and details on making a real good income.

SCIENTIFIC DIATHERMY CORP.

200 West 34th Street New York, N. Y.

MANY NEW RADIO BOOKS

have been added to the ever-popular RADIO - CRAFT LIBRARY SERIES. Please turn to page 184 of this issue and read the announcement on all the books in this series.

LES Correspondence Courses in RADIO and ELECTRICAL ENGINEERING

ELECTRICAL ENGINEERING Get good grasp of wide electrical field. Prepare yourself, at Low Cost, for secure future. Modern, simplified, you can understand quickly.

RADIO ENGINEERING Extra fine course in radio, public address, photo-electric work. Trains you to be super-service man, real vacuum tube technician. Extra kits furnished. Diploma on completion. Tuition, \$25, either course. Deferred payment plan.

FREE Get copies of school catalogs, student magazines, complete details. SEND NOW!

LINCOLN ENGINEERING SCHOOL, Box 931-87, LINCOLN, NEBR.

456 KC. SUPER COIL KIT BROADCAST BAND ONLY

KIT CONSISTS OF: 1-2 Gang condenser; 1-Ant. Coil; 1-Osc. Coil; 1-456 KC. Input I.F.; 1-456 KC. Output I.F.; 1-300-500 Padder; 1 Wiring Diagram. All ABOVE PARTS.....\$1.99

SAME AS ABOVE WITH-3 Gang condenser & Pre-selector coil.....\$1.99

25% Deposit Required with Order, Balance C.O.D.

ARROW SALES CO. 27 S. JEFFERSON ST. CHICAGO, ILL.

Complete Electric Plants

Osan A. C. plants furnish same current as city lines, 110 volt, 60 cycle. For farms, camps, construction jobs, operate radios, water systems, all appliances. New models, 350 to 5000 watts. 6, 12, 32 and 110 volt D.C. Models \$57.50 and up. Also combination A. C. - D. C. units. Shipped complete, ready to run.

Write for details.
D. W. ONAN & SONS
669 Royalston Ave., Minneapolis, Minnesota

FREE RADIO CATALOG 1001 BARGAINS

NEW 1939 catalog

Reserve your copy of this NEW 1939 Catalog No. 73-318 NOW. Remarkable values in radios, parts, public address systems, amateur equipment. Don't buy a thing in radio until you get your FREE copy. Send for it today! Use penny postcard.

WHOLESALE RADIO SERVICE CO., INC.
102 SIXTH AVENUE, NEW YORK, N. Y.

OPERATING NOTES

(Continued from preceding page)

this difficulty, replace the 3rd I.F. transformer, using RCA Stock No. 5230; remove resistor R44, R45 from the rear apron of the chassis and re-mount it on the chassis front apron adjacent to the power transformer, keeping connections in the original relation. Figure 9 of the Model D 22-1 Service Notes, published in the RCA bound volume of 1935, shows the resistor re-arranged as described. Re-align I.F. stages.

RCA MODELS 9-U AND 9-U-2

Phonograph Volume. Additional audio gain may be obtained on these instruments by increasing the value of resistor R42 of the input compensator pack from 2,200 ohms to 5,000-6,000 ohms. This change permits greater volume from older low-level recordings, and will not usually be necessary except in cases where the customer requires extra volume. Resistor R42 is located under the terminal board of the input transformer pack, and it will therefore be necessary to bend back the clamping tabs and to CAREFULLY lift the board away from the case to reach it.

RCA "OVER THE SOLDERING IRON"

BOOK REVIEW

TELEVISION—A STRUGGLE FOR POWER. by Frank C. Waldrop and Joseph Borkin (1938). Published by William Morrow and Co. Size, 5½ x 8 ins., cloth covers, 299 pages. Price \$2.75.

Waldrop, described by one commentator as a successful Washington political writer, and Borkin, a specialist in analyses of communications, treat in the modern fast style of presentation a subject which heretofore has had only technical approach.

Starting with the premise that television "is the synthesis of 20th Century communications: sound and motion picture, telegraph, telephone, radio," the authors envision for the reader the effect of this "new wonder" on real estate values—on the political scene—on international relations—on education—on the home itself. Introduction by George Henry Payne, member of the F.C.C., is included.

The authors in their Preface state that the subject of this book is to show in the simplest possible manner the relationships by the apparently diverse interests of "technical research; by the economics of telegraphy, telephony, newspapers, the stage, sound motion pictures and sound radio; by laws of Congress, acts of regulatory commissions and decisions of high courts; by programs of education and entertainment, free speech, censorship, private and public morals; and by the rights of individuals seeking reward for skill and genius at invention." and the struggle of each for dominance.

Albeit the writers draw heavily upon their imaginations, the book derives additional merit from this fact in view of their keen analyses of frequent quotations (of authoritative references) which tend to support their every contention; and it is only by such foresighted treatment that the authors are able to keep one step ahead of this rapidly advancing Art. We recommend this book to your reading table.

DITTY-DITTY-DO

THE monotone chant of the tobacco auctioneer on N.B.C.'s Lucky Strike program isn't the verbal goulash that you think it is.

Perhaps all that makes sense to your ears comes at the very end of the 20-second staccato spluttering when the auctioneer announces, "Sold American! All done! Sold! Sold to the American Tobacco Company!"

But if the preliminary gibberish were taken in slow motion, it would break down into something like this: 4-34-35-39-44 (a mere recitation of bids) and "ditty-ditty-do ditty-ditty-do . . ." (an alliterative mouthful meaning "ditto.") Put them all together and you have the chant of the tobacco auctioneer.

The chanting heard on Kay Kyser's Musical Klass and Dance (Wednesdays, 10:00 p.m., E.D.S.T., N.B.C.-Red Network) is done by Forest Boone and L. A. (Speed) Riggs.

Index to advertisers

A

Aerovox Corporation.....183
Allied Radio Corporation.....167
American Television Institute, Inc.Back cover
Amperite Corporation.....170
Amplifier Co. of America.....176
Amy, Aceves & King, Inc.....169
Arrow Sales Company.....190

B

The Brush Development Co.....190
Burstein-Applebee Company.....176

C

Capitol Radio Engineering Institute.....185
Central Radio Labs.....173
Cinaudagraph Corporation.....179
Classified & Swap Section.....188
The Commonwealth Mfg. Corp.....168
Cornell-Dubilier Corporation.....177
Coyne Electrical School.....181

H

Hammarlund Mfg. Company.....187
Hudson Specialties Company.....186
Hygrade Sylvania Corporation.....171

I

International Correspondence Schools.....187

L

Lancaster, Allwine & Rommel.....176
Lincoln Engineering School.....190

M

Million Radio & Tel. Labs.....185
Modell's185

N

National Plans Institute.....174
National Radio Institute.....179
National Schools174
National Union Radio Corp.....179
New York YMCA Schools.....176

O

D. W. Onan & Sons.....190

R

Radio & Technical Publ. Co.....173
Radio Circular Company.....175
Radio City Products Company.....175
Radio Publications.....182
Radio Servicemen of America, Inc.....178
Radolek Company.....189
RCA Institutes, Inc.....176
Readrite Meter Works.....183
Reliable Radio Company.....170
Remington Rand, Inc.....174
John F. Rider.....187

S

Scientific Diathermy Corp.....190
Solar Mfg. Company.....185
Sprague Products Company.....181
Sprayberry Academy of Radio.....177
Superior Instruments Co... Inside Front Cover
Supreme Instruments Corp.....131B

T

Technifax168
Teletran Products Company.....172
Test Equipment Co. of America.....169
William A. Thomas Co.....187
Triplett Elect. Instr. Co.....181

U

United Radio Company.....187

W

Wellworth Trading Company.....172, 176
Weston Elect. Instrument Corp. Inside Back Cover
Wholesale Radio Service Co., Inc.....190
Wright-DeCoster, Inc.....189

(While every precaution is taken to insure accuracy, we cannot guarantee against the possibility of an occasional change or omission in the preparation of this index.)

Please Say That You Saw It in RADIO-CRAFT

Still time

... TO GET THIS
COMPLETE SERVICE BENCH

FREE!



1st PRIZE

This complete servicemen's test bench, including a high-sensitivity Analyzer, Socket Selector Set, Tube Checker, All-wave A.A.C. Oscillator, set of 8 Service Manuals, service tools and replacement tubes.

THE INSTRUMENTS
which make
any Service Bench
Complete

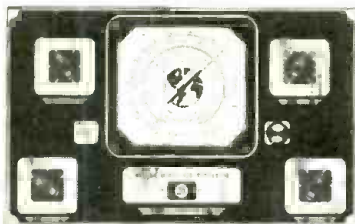

WESTON Model 776
all wave, hand-calibrated Oscillator



WESTON Model 772
Super Sensitive
Analyzer

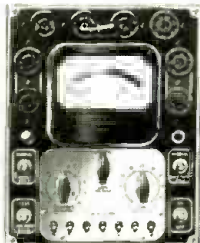

WESTON Model 773
Tube Checker
(available in counter
and portable types)

... and 24 other awards in WESTON'S "50th Anniversary" Contest!

Get your entry blank today! Write 100 to 250 words telling "How Modern Test Equipment Helped Me Solve A Difficult Servicing Problem." Send in your entry before September 1st, and, if your answer is judged the most practical and most interesting, the completely equipped service bench shown above will be shipped to you FREE! And there are 24 other awards ... all WESTON test equipment ... being offered in this contest by WESTON in celebrating its 50th Anniversary of instrument leadership.

The contest is open to all individuals actively engaged in radio servicing, except WESTON employees or representatives. The contest rules, the complete list of prizes, and complete instructions are included on the entry blank. Be sure you enter today.

*Get entry blanks from your jobber,
or return the coupon today.*

WESTON

Radio Instruments

Weston Electrical Instrument Corporation
599 Frelinghuysen Avenue, Newark, N. J.
Send entry blank for WESTON'S "50th Anniversary" Contest

Name
Address
City State

TELEVISION

Cannot Be Properly Mastered With Just Texts Alone...You Need ACTUAL Experience WORKING With Real Equipment!

THAT'S WHY WE GIVE YOU THIS Professional Television EQUIPMENT INCLUDED WITH YOUR TRAINING AT NO EXTRA COST

Get In on the Ground Floor Now!

Already there are 16 Telecasting Stations in America. Television Programs are on the air. Television Receivers are on sale. These facts are undisputable indications that the beginning of Television has arrived. Wide-awake men who are alert to the great possibilities of a career in Television are preparing NOW! Don't wait until the field is crowded. Get in on the ground floor first! The A.T.I. method of training is new, startlingly different. No dull, hard-to-understand, monotonous texts. We train you as you never thought you could be trained . . . you get ACTUAL EXPERIENCE with YOUR OWN TELEVISION APPARATUS just like on the real job . . . RIGHT IN YOUR OWN HOME!

Prepare Now for the Big Pay Television Jobs

A.T.I. Training prepares you for good paying jobs in these fields: Television Engineer, Radio Station Operator, Laboratory Technician, Radio-Electronic Engineer, Sound Camera Technician, Public Address Engineer, Electrician and many other fascinating profitable positions. A.T.I. Training qualifies you during the first few months to take your RADIO TELEPHONE FIRST CLASS GOVERNMENT LICENSE EXAMINATION. A complete Radio Servicing Course is also included.



Edward Gibbons, WDTAK, says, "I have worked with A.T.I. equipment. It lends itself perfectly to experimental work and hundreds of tests which give you a first hand practical knowledge of television."



E. F. Wiechmann, WDR1A, says, "I am tremendously impressed by the size and quality of your equipment. The cathode ray tube and four photo electric cells alone are worth the entire price you ask for the complete machine and training."

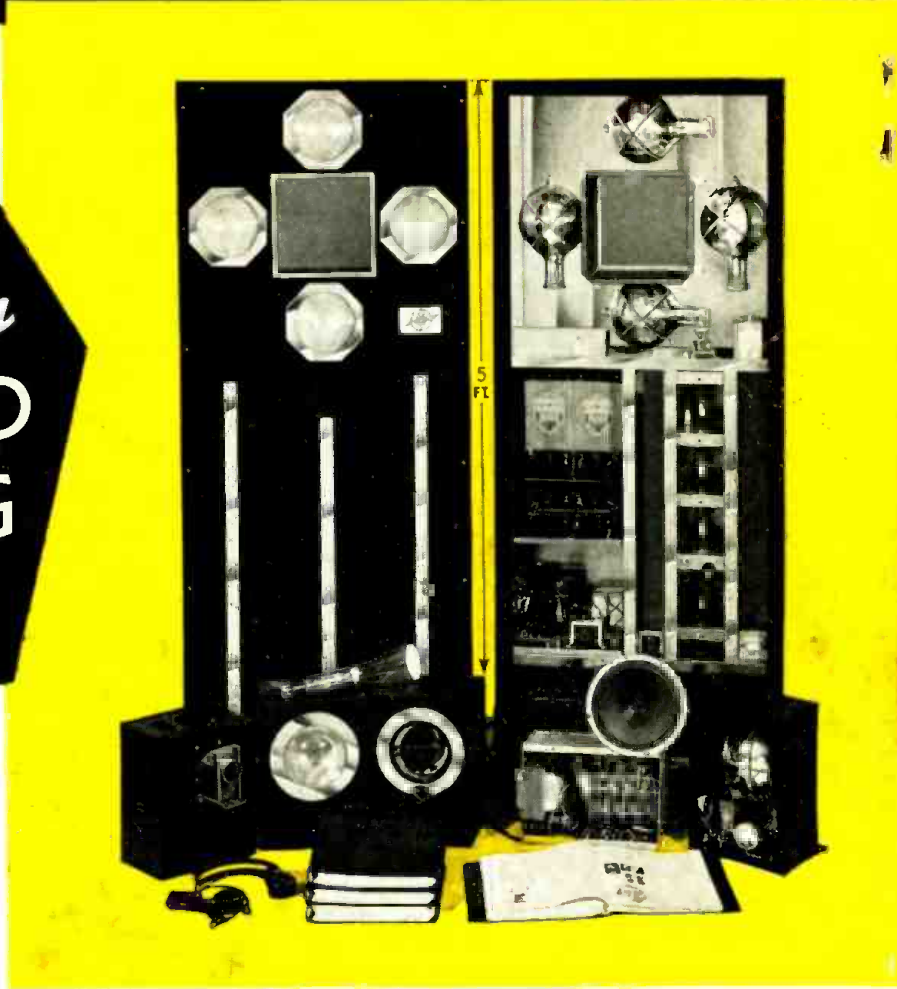

Here's What You Get . . .

Television cannot be properly mastered by texts alone. That's why we give you all this genuine Television equipment along with your A.T.I. training AT NO EXTRA COST. It is sent to you at home and is yours to keep. Includes a complete professional Television Transmitter and Receiver 5 ft. high; 50 Watt Radio Transmitter; Superheterodyne Receiver; 7" x 21" Cathode Ray Tube with 7" screen; 4 Giant Photo-Electric Cells; Hi-Gain Transmission Amplifier; Projector; Mazdas; Lenses; Phones; R.C.A. Tubes; and all other necessary apparatus. We give you a full engineering course in Television, Electronics, Radio Servicing and Electricity, with final training in Chicago in our laboratories (transportation to Chicago paid).

Here's What You Can Do . . .

With your A.T.I. Equipment you can make over \$50 amazing, interesting experiments right in your own home. You can produce your own Television program for a local audience . . . transmitting and receiving the faces of your friends. You can build complete Television Transmission and Reception Systems, Television Amplifiers, Radio Transmitters, Television Pick-ups, Photo-Electric Relays, Light Beam Telephone, Grid-Glow Alarms, Sound Amplifiers, Photo-Electric Photometers. You can make hundreds of comparison tests that show you Television and Radio in a quick, simple way . . . much easier to understand than just mere words in a book. The entire A.T.I. course with the above equipment is remarkably low in price and on terms arranged to suit you. It costs you nothing to thoroughly investigate. SEND Coupon Now!

A.T.I. TRAINING WITH COMPLETE EQUIPMENT IS AVAILABLE ON AMAZINGLY LOW EASY MONTHLY PAYMENTS

AMERICAN TELEVISION INSTITUTE

433 E. Erie St., Dept. RC-938, Chicago, Ill.

Gentlemen: Please send me your free book on Television and literature describing A.T.I. Training. It is understood that this is FREE. No obligation.

Name Age

Address

City State



GET THE REAL *Inside* FACTS ON TELEVISION